

## ZF 7645

Vertical offset, direct or remote mount marine transmission.

### Description

- 3 shaft, reverse reduction transmission with hydraulic clutch mounted on the input shaft and another one mounted on the reverse shaft. Input drive on opposite side to output drive.
- Non-reversing NR version also available .
- Fully works tested, reliable and simple to install .
- Suitable for commercial vessels in all applications as well as for motoryachts etc .
- Design, manufacture and quality control standards comply with ISO 9001 and AQAP .
- Compatible with all types of engines and propulsion systems, including waterjets and surface-piercing propellers and cpps .

### Features

- Lightweight and robust aluminum alloy casing (sea water resistant) .
- Case hardened and precisely ground gear teeth for long life and smooth running .
- Output shaft thrust bearing designed to take maximum propeller thrust astern and ahead .
- Smooth and reliable hydraulic shifting with control lever for attachment of push-pull cable or other operating system .
- Compact, space-saving design, complete with oil cooler, pump and full flow filter .
- Suitable for multi engine installation (same ratio and torque capacity engine wise or counter engine wise .

### Options

- Engine-matched torsional coupling .
- Mounting brackets for rigid connection to foundation or elastic mounting brackets .
- Trolling valve for slow-speed drive .
- Propeller shaft flange and coupling bolt sets .
- SAE 00 bell housing for centering only .
- Monitoring kit .
- Trailing pump .
- PTO (live) .
- Electric clutch control (24 VDC) .
- Classification by all major Classification Societies on request .
- "AUTOTROLL" .

# ZF 7645

## Ratings

### Pleasure Duty

RATIOS	MAX. TORQUE		POWER/RPM		INPUT POWER CAPACITY						MAX. RPM
	Nm	ftlb	kW	hp	1800 rpm		2000 rpm		2100 rpm		
					kW	hp	kW	hp	kW	hp	
<span style="color: red;">■</span> 3.308*, 3.440, 3.625*, 3.826*, 4.000, 4.238*, 4.500	13400	9883	1.4031	1.8816	2526	3387	2806	3763	2947	3951	2300

\* Special Order Ratio.

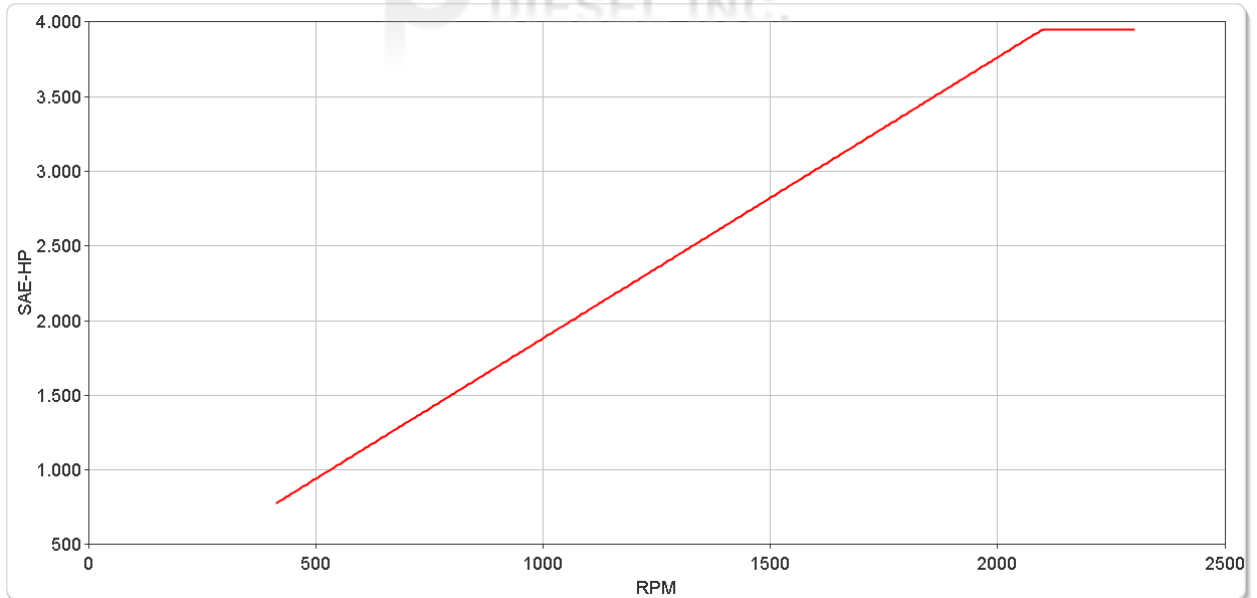
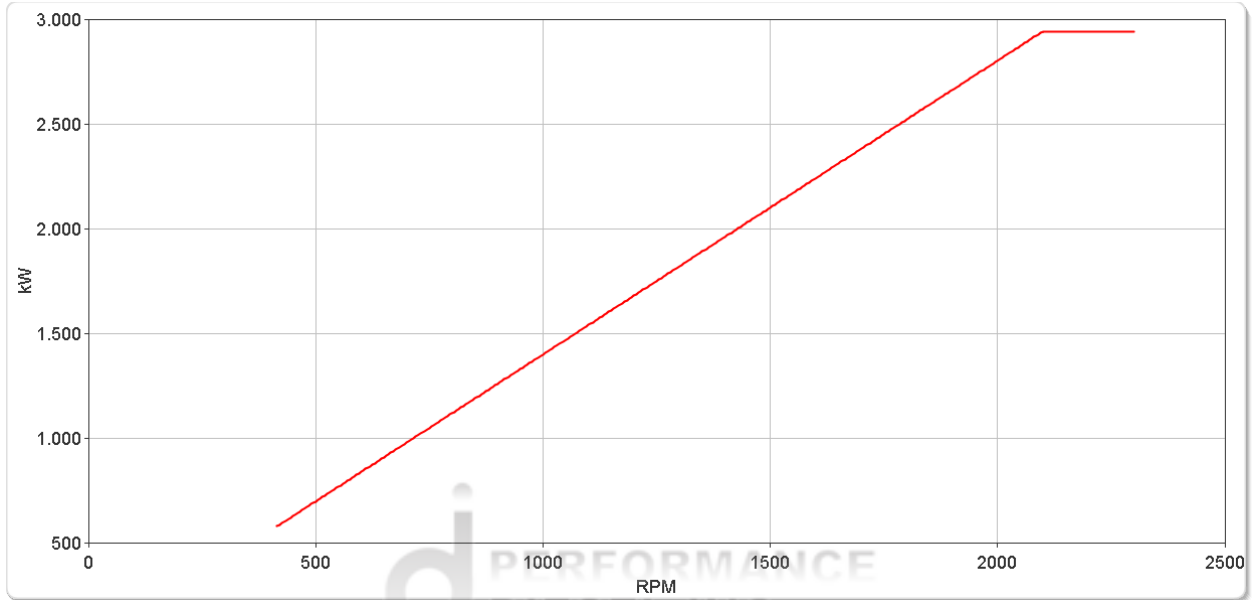

# ZF 7645

## Ratings

### Light Duty

RATIOS	MAX. TORQUE		POWER/RPM		INPUT POWER CAPACITY						MAX. RPM
	Nm	ftlb	kW	hp	1800 rpm		2000 rpm		2100 rpm		
					kW	hp	kW	hp	kW	hp	
<span style="color: red;">■</span> 3.308*, 3.440, 3.625*, 3.826*, 4.000, 4.238*, 4.500	13400	9883	1.4031	1.8816	2526	3387	2806	3763	2947	3951	2300

\* Special Order Ratio.

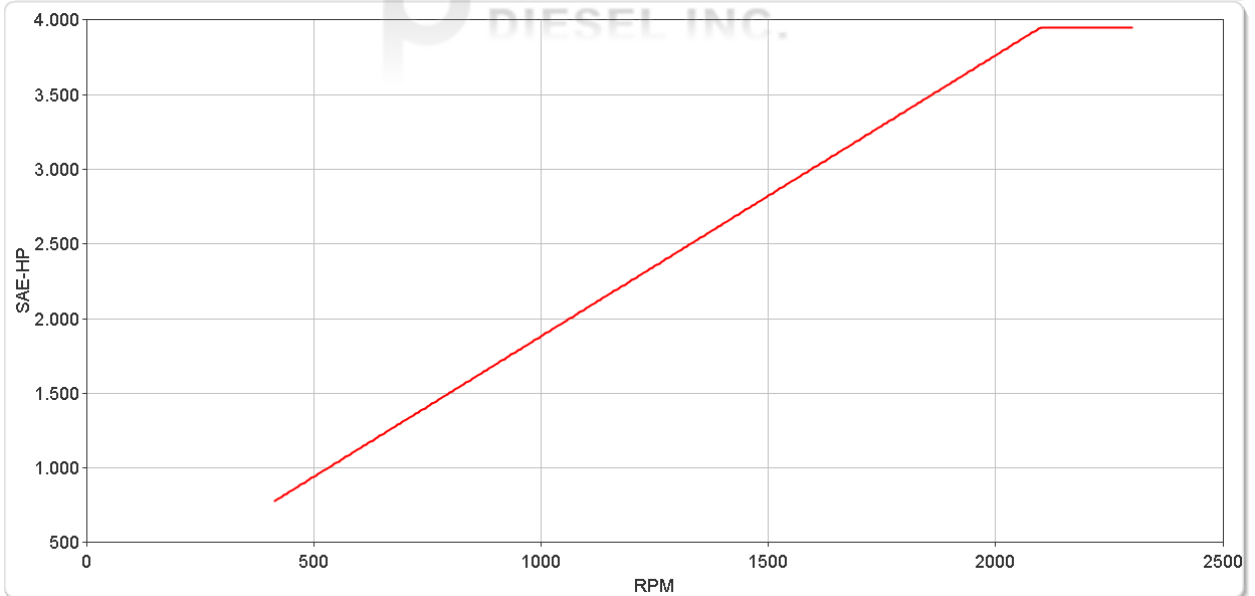
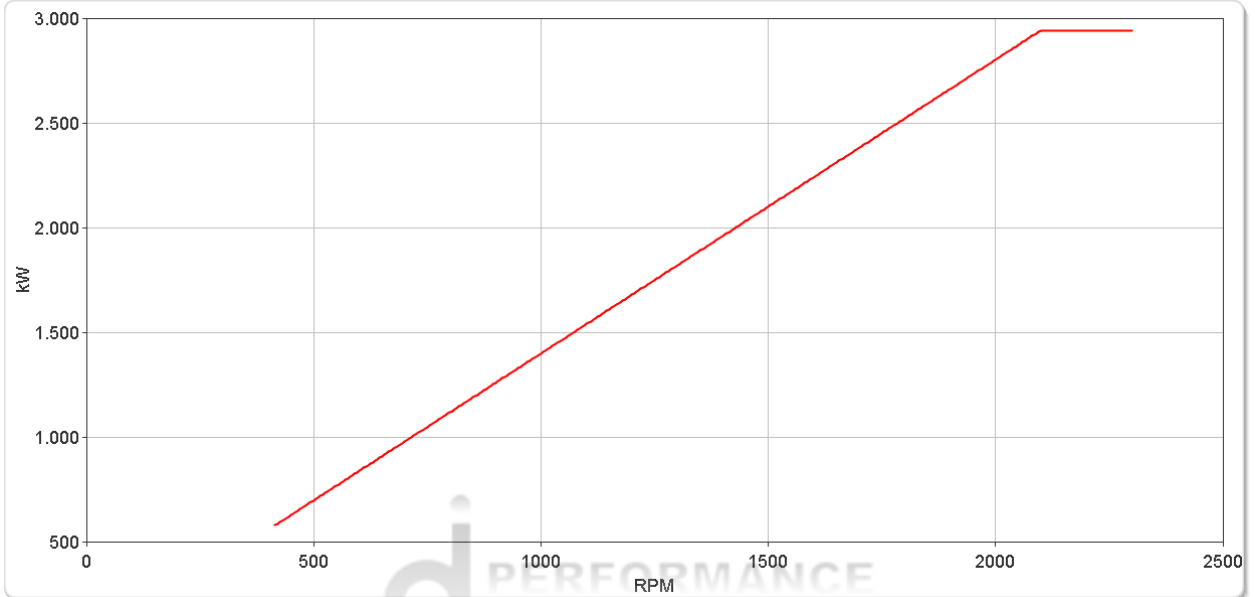

# ZF 7645

## Ratings

### Medium Duty

RATIOS	MAX. TORQUE		POWER/RPM		INPUT POWER CAPACITY						MAX. RPM
	Nm	ftlb	kW	hp	1600 rpm		1800 rpm		2000 rpm		
					kW	hp	kW	hp	kW	hp	
<span style="color: red;">■</span> 3.308*, 3.440, 3.625*, 3.826*, 4.000, 4.238*	12540	9249	1.3131	1.7609	2101	2817	2364	3170	2626	3522	2300
<span style="color: blue;">■</span> 4.500	11880	8762	1.2440	1.6682	1990	2669	2239	3003	2488	3336	2300

\* Special Order Ratio.

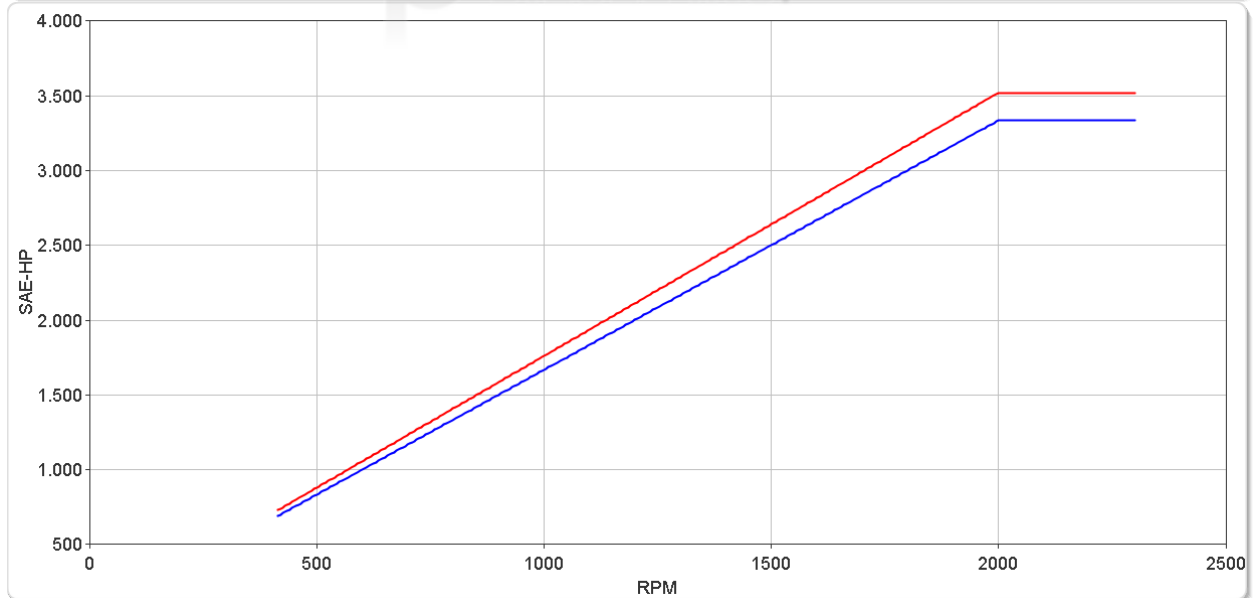
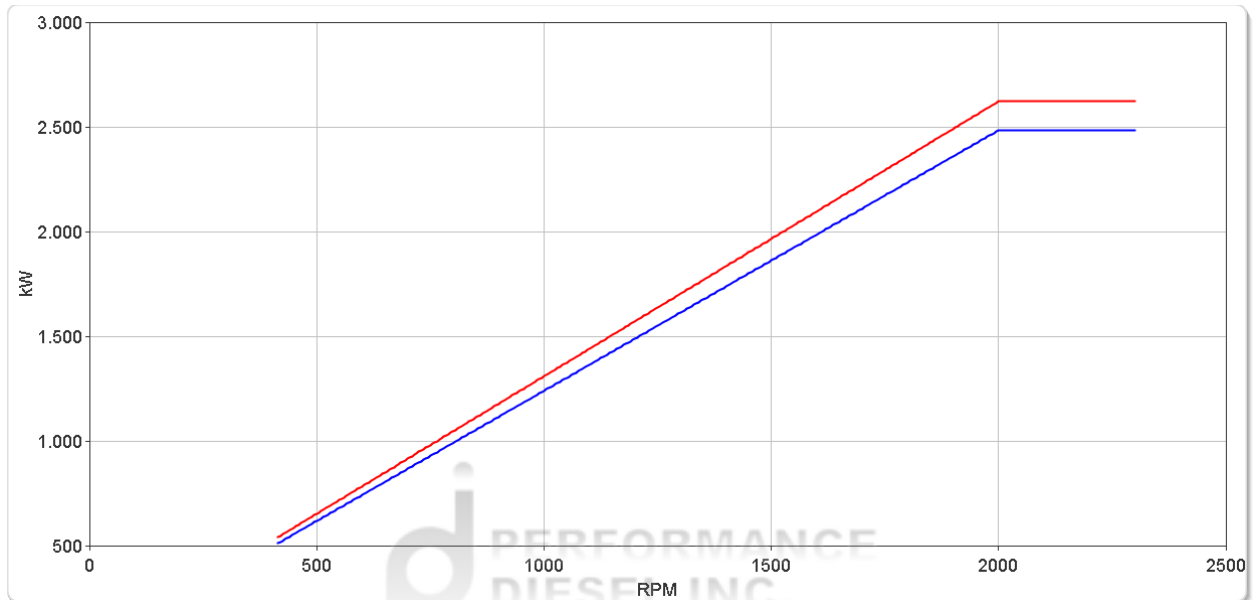

# ZF 7645

## Ratings

### Continuous Duty

RATIOS	MAX. TORQUE		POWER/RPM		INPUT POWER CAPACITY						MAX. RPM
	Nm	ftlb	kW	hp	1200 rpm		1600 rpm		1800 rpm		
<span style="color: red;">■</span> 3.308*, 3.440, 3.625*, 3.826*, 4.000, 4.238*	11000	8113	1.1518	1.5446	1382	1854	1843	2471	2073	2780	1800
<span style="color: blue;">■</span> 4.500	10300	7597	1.0785	1.4463	1294	1736	1726	2314	1941	2603	1800

\* Special Order Ratio.

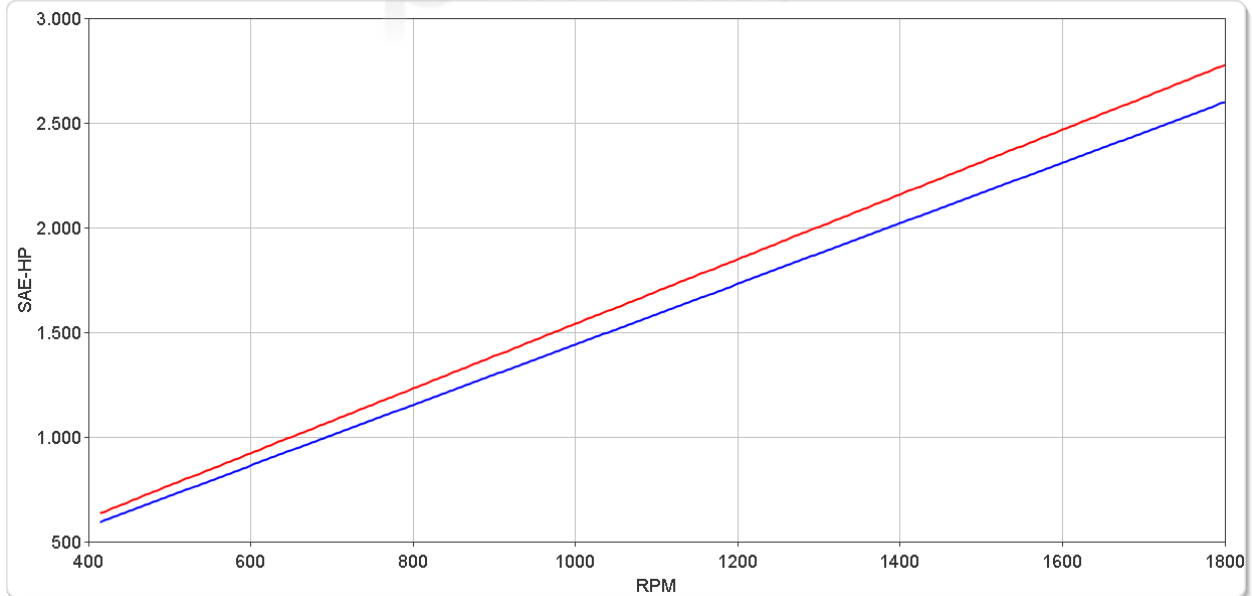
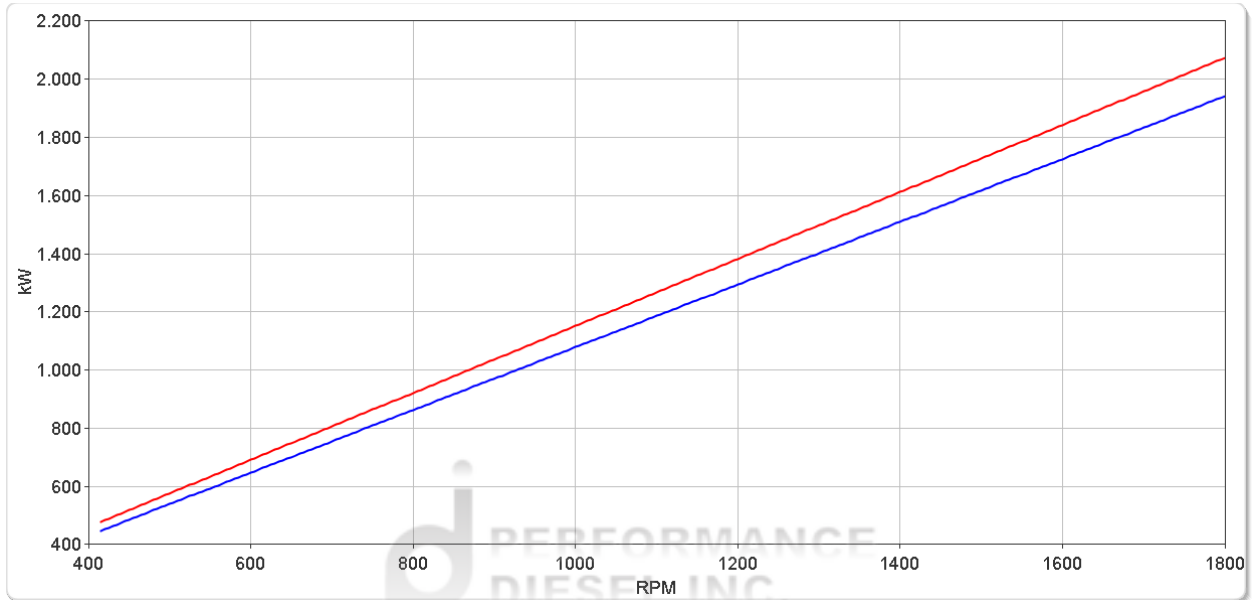

# ZF 7645

## Dimensions

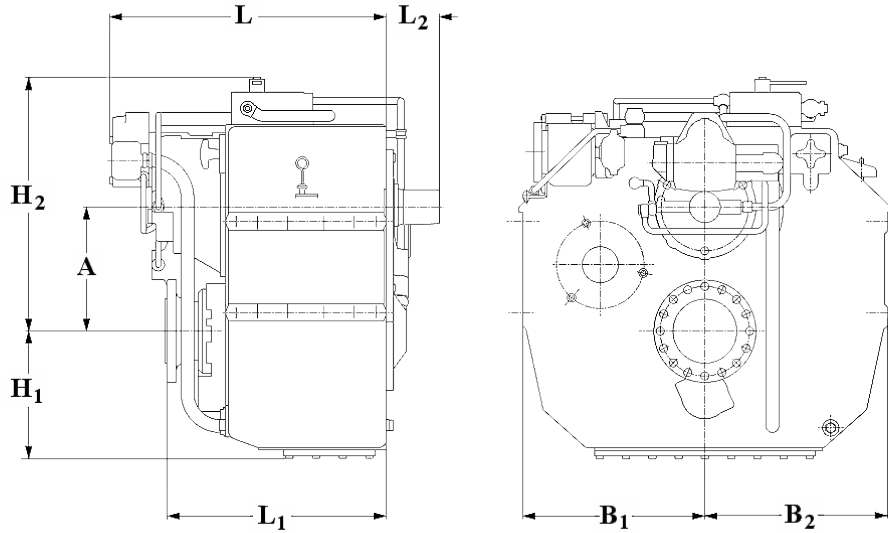

mm (inches)										
A	B <sub>1</sub>	B <sub>2</sub>	H <sub>1</sub>	H <sub>2</sub>	L	L <sub>1</sub>	L <sub>2</sub>	L <sub>3</sub>	Bell Hsg.	
450 (17.7)	500 (19.7)	500 (19.7)	430 (16.9)	806 (31.7)	761 (30.0)	657 (25.9)	146 (5.75)	-		
Weight kg (lb)					Oil Capacity Litre (US qt)					
1,325 (2,915)					80.0 (84.8)					

### Output Coupling Dimensions

A		B		C		D		Bolt Holes			
mm	in	mm	in	mm	in	mm	in	No.	Diameter (E)		
435	17.1	385	15.2	330	13.0	35.0	1.38	20	30.4	1.20	

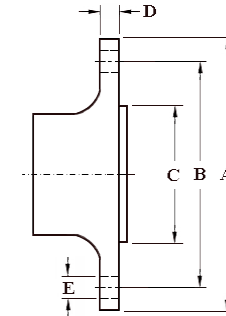

## Duty Definitions

<b>PLEASURE DUTY DEFINITION</b>	Highly intermittent operation with very large variations in engine speed and power
Average engine operating hours limit:	500 hours/year 300 hours/year for mechanical gearboxes
Typical hull forms:	Planing.
Typical applications:	Private, non-commercial, non-charter sport/leisure activities.
<b>LIGHT DUTY DEFINITION</b>	Intermittent operation with large variations in engine speed and power
Average engine operating hours limit:	2500 hours/year (for hydraulic gearboxes smaller than the ZF 650 series, 2000 hours/year).
Typical hull forms:	Planing and semi-displacement.
Typical applications:	Private and charter, sport/leisure activities, naval and police activities.
<b>MEDIUM DUTY DEFINITION</b>	Intermittent operation with some variations in engine speed and power
Average engine operating hours limit:	4000 hours/year. 3500 hours/year for gearboxes smaller than ZF 2000 series and workboat ZF W2700 series.
Typical hull forms:	Semi-displacement and displacement
Typical applications:	Charter and commercial craft (example: crew boats and fast ferries), and naval and police activities.
<b>CONTINUOUS DUTY DEFINITION</b>	Continuous operation with little or no variations in engine speed and power
Average engine operating hours limit:	Unlimited
Typical hull forms:	Displacement.
Typical applications:	Heavy duty commercial vessels, tugs, fishing boats.

## Duty Ratings

Ratings apply to marine diesel engines at the indicated speeds. At other engine speeds, the respective power capacity (kW) of the transmission can be obtained by multiplying the Power/Speed ratio by the speed.

Approximate conversion factors:

1 kW = 1.36 metric hp

1 kW = 1.34 U.S. hp (SAE)

1 U.S. hp = 1.014 metric hp

1 Nm = 0.74 lb.ft.

Ratings apply to right hand turning engines, i.e. engines having counterclockwise rotating flywheels when viewing the flywheel end of the engine.

These ratings allow full power through forward and reverse gear trains, unless otherwise stated.

Contact your nearest ZF Sales and Service office for ratings applicable to gas turbines, gasoline (petrol) engines, as well as left hand turning engines, and marine transmissions for large horsepower capacity engines.

Ratings apply to marine transmissions currently in production or in development and are subject to change without prior notice.

**NOTE: THE MAXIMUM RATED INPUT POWER MUST NOT BE EXCEEDED (SEE RESPECTIVE RATINGS IN THE TECHNICAL DATA SHEETS)**

## Safe Operating Notice

The safe operation of ZF products depends upon adherence to technical data presented in our brochures. Safe operation also depends upon proper installation, operation and routine maintenance and inspection under prevailing conditions and recommendations set forth by ZF. Damage to transmission caused by repeated or continuous emergency manoeuvres or abnormal operation is not covered under warranty. It is the responsibility of users and not ZF to provide and install guards and safety devices, which may be required by recognized safety standards of the respective country (e.g. for U.S.A. the Occupational Safety Act of 1970 and its subsequent provisions).

## Monitoring Notice

The safe operation of ZF products depends upon adherence to ZF monitoring recommendations presented in our operating manuals, etc. It is the responsibility of users and not ZF to provide and install monitoring devices and safety interlock systems as may be deemed prudent by ZF. Consult ZF for details and recommendations.

## Torsional Responsibility and Torsional Couplings

The responsibility for ensuring torsional compatibility rests with the assembler of the drive and driven equipment. ZF can accept no liability for gearbox noise caused by vibrations or for damage to the gearbox, the flexible coupling or to other parts of the drive unit caused by this kind of vibration. Contact ZF for further information and assistance. ZF recommends the use of a torsional limit stop for single engine powered boats, wherein loss of propulsion power can result in loss of control. It is the buyer's responsibility to specify this option, which can result in additional cost and a possible increase in installation length.

ZF can accept no liability for personal injury, loss of life, or damage or loss of property due to the failure of the buyer to specify a torsional limit stop. ZF selects torsional couplings on the basis of nominal input torque ratings and commonly accepted rated engine governed speeds. Consult ZF for details concerning speed limits of standard offering torsional couplings, which can be less than the transmission limit. Special torsional couplings may be required for Survey Society Ice Classification requirements.

