



ZF 24040 NR2B

Vertical offset, remote mount marine transmission.

Description

- 2 shaft non reverse reduction transmission with hydraulic clutch mounted on the input shaft.
- Input shaft vertical below output shaft.
- Fully works tested, reliable and simple to install .
- Suitable for heavy duty fast ferry applications. Also suitable for other weight sensitive craft, e.g. high speed motor yachts .
- Design, manufacture and quality control standards comply with ISO 9001 and AQAP .
- Compatible with all types of engines.
- Compact, space-saving design, complete with oil cooler, pump and full flow filter.

Features

- Lightweight cast aluminum alloy housing resistant to sea water corrosion. .
- Case hardened and precisely ground gear teeth for long life and smooth running .
- Suitable for multi engine installations.
- Airborn and structure born noise in accordance to ISO 8579 .

Options

- Classification by all major Classification Societies on request .
- Engine-matched torsional coupling .
- Input flange .
- Monitoring kit .
- Mounting brackets .
- Trailing pump .
- Power take off (PTO) live with SAE connection, driven from the input shaft. .



ZF 24040 NR2B

Ratings

Light Duty

RATIOS	MAX. TORQUE		POWER/RPM		INPUT POWER CAPACITY						MAX. RPM
	Nm	ftlb	kW	hp	1800 rpm		2000 rpm		2100 rpm		
					kW	hp	kW	hp	kW	hp	
1.514*, 2.032, 2.577, 2.760*, 3.043, 3.476	20000	14751	2.0942	2.8084	3770	5055	4188	5617	4398	5898	2300
3.700*	19047	14048	1.9945	2.6746	3590	4814	3989	5349	4188	5617	2300
3.947*	18094	13345	1.8947	2.5408	3410	4573	3789	5082	3979	5336	2300

* Special Order Ratio.

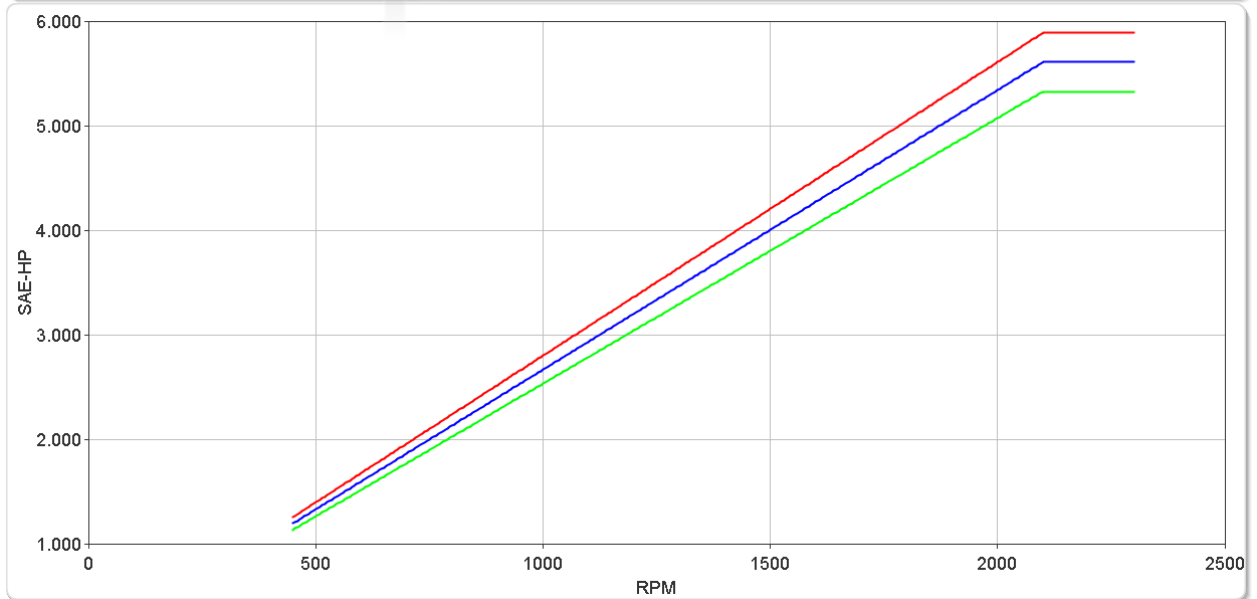
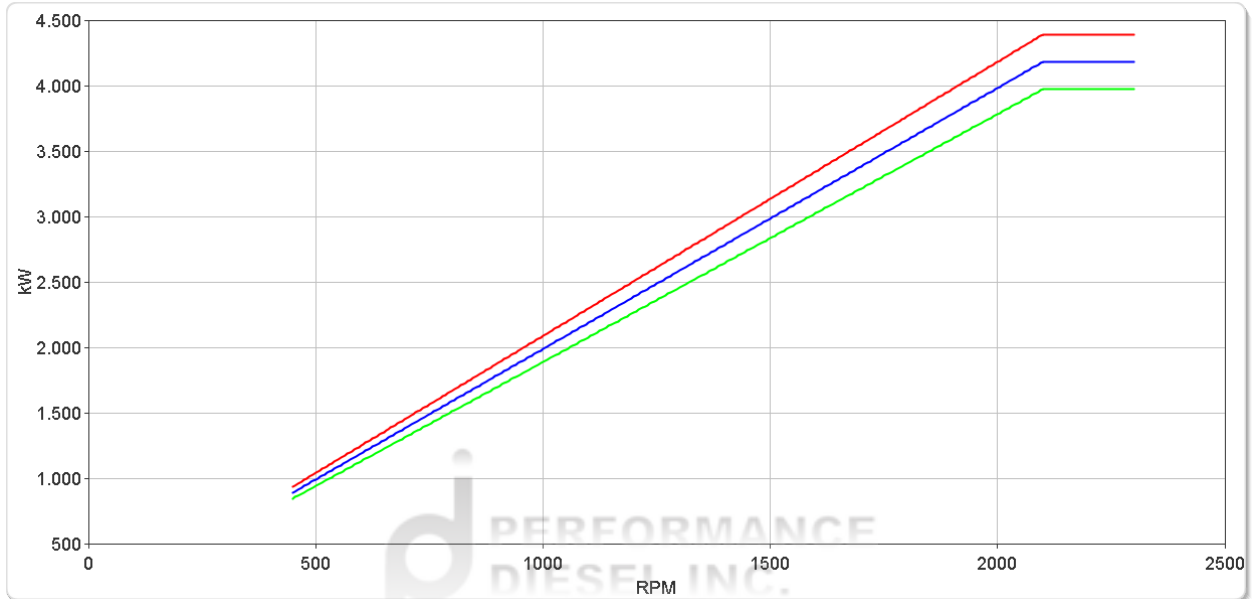

ZF 24040 NR2B

Ratings

Medium Duty

RATIOS	MAX. TORQUE		POWER/RPM		INPUT POWER CAPACITY						MAX. RPM
	Nm	ftlb	kW	hp	1600 rpm		1800 rpm		2000 rpm		
					kW	hp	kW	hp	kW	hp	
1.514*, 2.032, 2.577, 2.760*, 3.043, 3.476	16929	12486	1.7727	2.3772	2836	3804	3191	4279	3545	4754	2300
3.700*	16122	11891	1.6882	2.2639	2701	3622	3039	4075	3376	4528	2300
3.947*	15316	11297	1.6038	2.1507	2566	3441	2887	3871	3208	4301	2300

* Special Order Ratio.

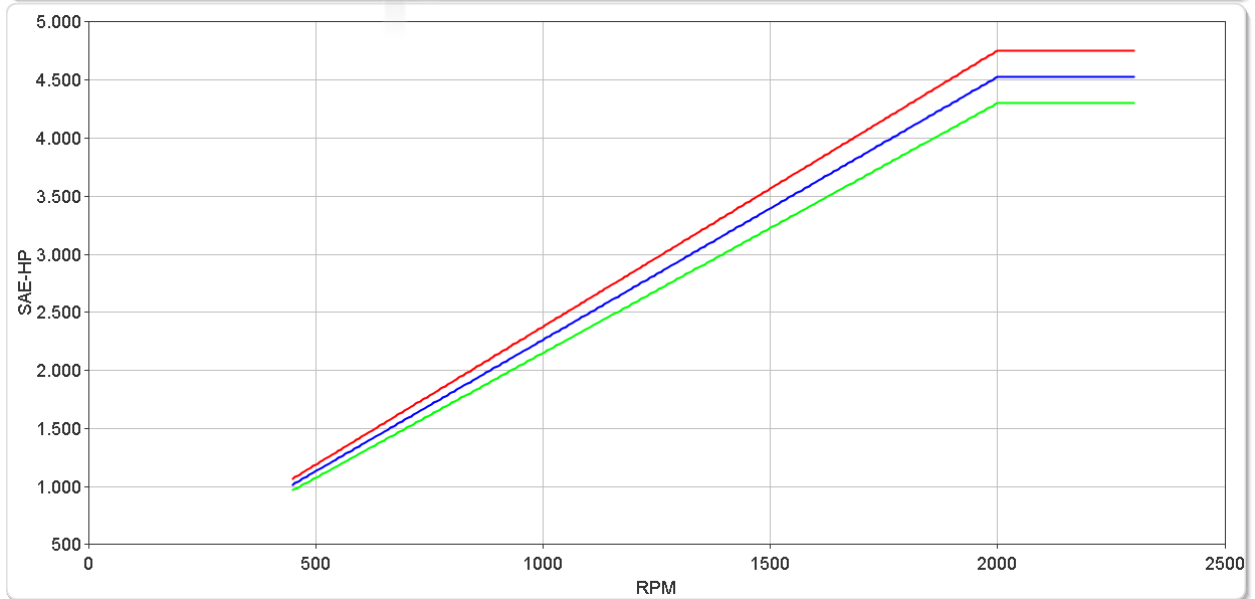
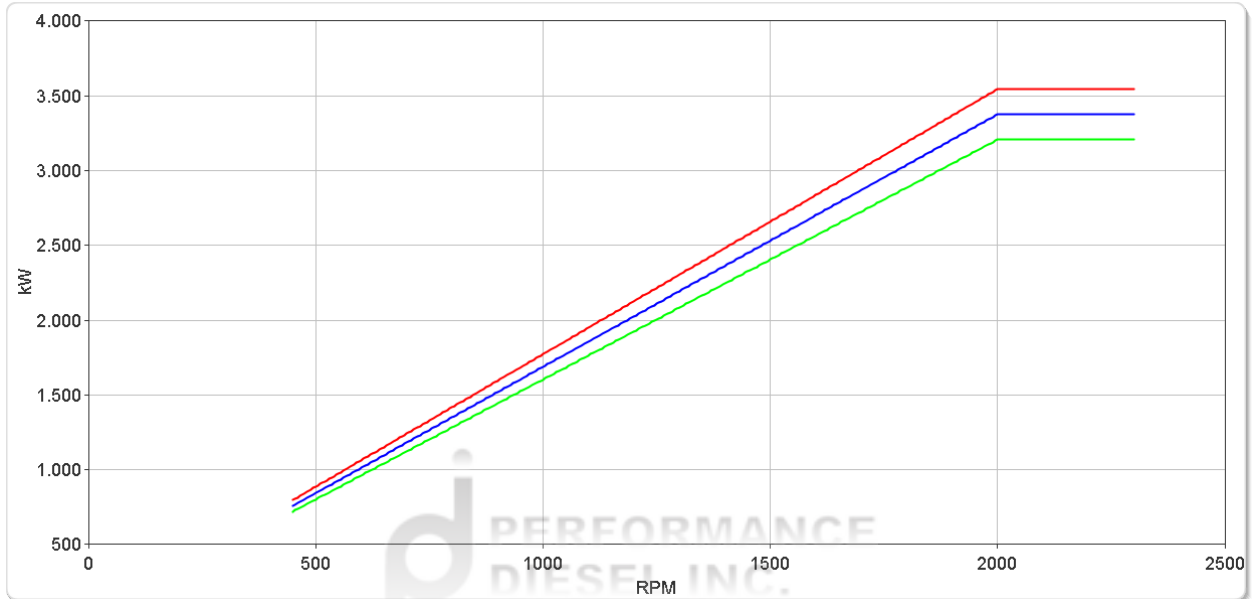

ZF 24040 NR2B

Ratings

Continuous Duty

	RATIOS	MAX. TORQUE		POWER/RPM		INPUT POWER CAPACITY						MAX. RPM
		Nm	ftlb	kW	hp	1200 rpm		1600 rpm		1800 rpm		
						kW	hp	kW	hp	kW	hp	
■	1.514*, 2.032, 2.577, 2.760*, 3.043, 3.476	13386	9873	1.4017	1.8797	1682	2256	2243	3007	2523	3383	1800
■	3.700*	12748	9402	1.3349	1.7901	1602	2148	2136	2864	2403	3222	1800
■	3.947*	12110	8932	1.2681	1.7005	1522	2041	2029	2721	2283	3061	1800

* Special Order Ratio.

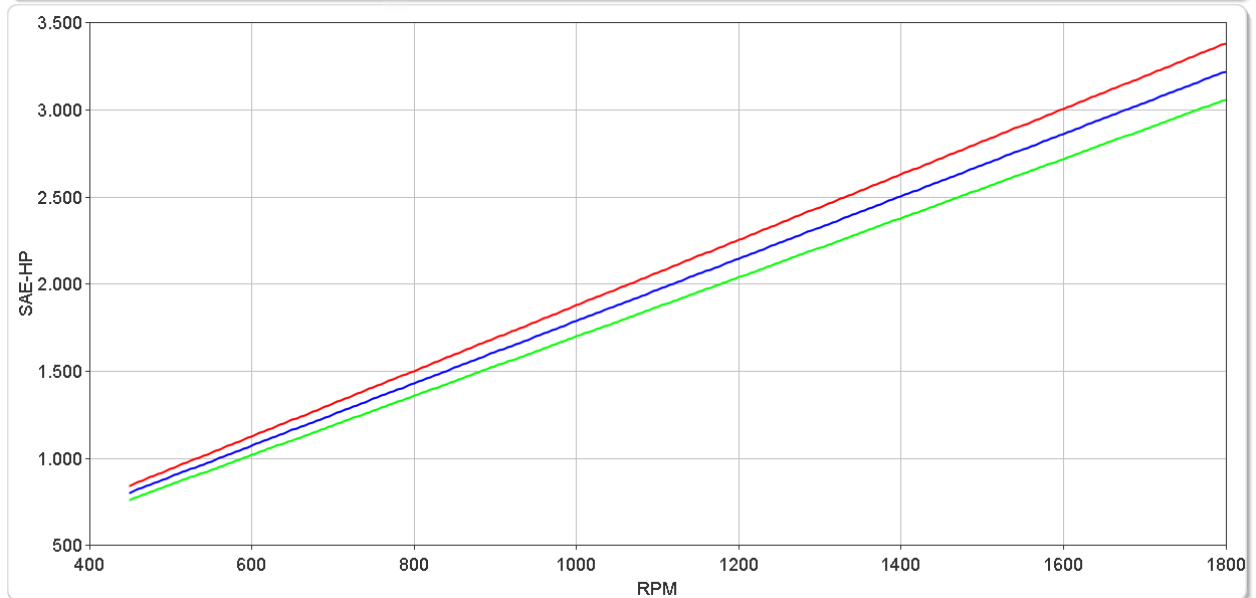
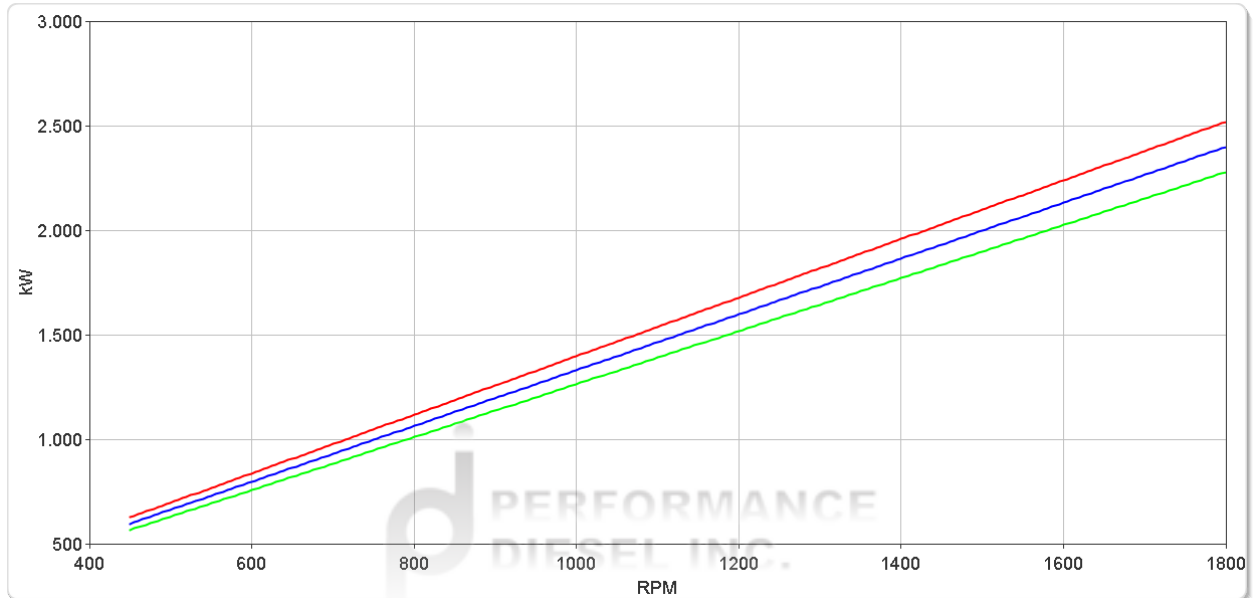

ZF 24040 NR2B

Dimensions

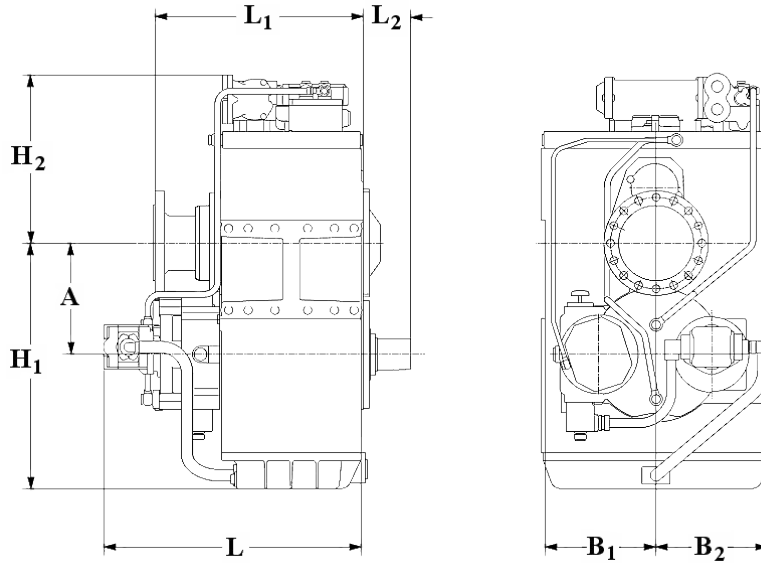

mm (inches)							
A	B ₁	B ₂	H ₁	H ₂	L	L ₁	L ₂
475 (18.7)	455 (17.9)	455 (17.9)	440 (17.3)	1,112 (43.8)	1,032 (40.6)	750 (29.5)	480 (18.9)
Weight kg (lb)				Oil Capacity Litre (US qt)			
1,630 (3,586)				75.0 (80.0)			

Output Coupling Dimensions

A		B		C		D		No.	Bolt Holes Diameter (E)	
mm	in	mm	in	mm	in	mm	in		mm	in
435	17.1	385	15.2	330	13.0	46.0	1.81	20	30.4	1.20

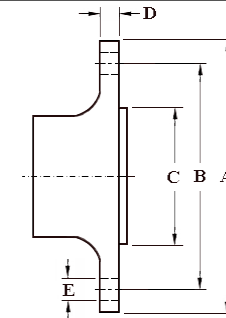

Duty Definitions

LIGHT DUTY DEFINITION	Intermittent operation with large variations in engine speed and power
Average engine operating hours limit:	2500 hours/year (for hydraulic gearboxes smaller than the ZF 650 series, 2000 hours/year).
Typical hull forms:	Planing and semi-displacement.
Typical applications:	Private and charter, sport/leisure activities, naval and police activities.
MEDIUM DUTY DEFINITION	Intermittent operation with some variations in engine speed and power
Average engine operating hours limit:	4000 hours/year. 3500 hours/year for gearboxes smaller than ZF 2000 series and workboat ZF W2700 series.
Typical hull forms:	Semi-displacement and displacement
Typical applications:	Charter and commercial craft (example: crew boats and fast ferries), and naval and police activities.
CONTINUOUS DUTY DEFINITION	Continuous operation with little or no variations in engine speed and power
Average engine operating hours limit:	Unlimited
Typical hull forms:	Displacement.
Typical applications:	Heavy duty commercial vessels, tugs, fishing boats.

Duty Ratings

Ratings apply to marine diesel engines at the indicated speeds. At other engine speeds, the respective power capacity (kW) of the transmission can be obtained by multiplying the Power/Speed ratio by the speed.

Approximate conversion factors:

1 kW = 1.36 metric hp

1 kW = 1.34 U.S. hp (SAE)

1 U.S. hp = 1.014 metric hp

1 Nm = 0.74 lb.ft.

Ratings apply to right hand turning engines, i.e. engines having counterclockwise rotating flywheels when viewing the flywheel end of the engine.

These ratings allow full power through forward and reverse gear trains, unless otherwise stated.

Contact your nearest ZF Sales and Service office for ratings applicable to gas turbines, gasoline (petrol) engines, as well as left hand turning engines, and marine transmissions for large horsepower capacity engines.

Ratings apply to marine transmissions currently in production or in development and are subject to change without prior notice.

NOTE: THE MAXIMUM RATED INPUT POWER MUST NOT BE EXCEEDED (SEE RESPECTIVE RATINGS IN THE TECHNICAL DATA SHEETS)

Safe Operating Notice

The safe operation of ZF products depends upon adherence to technical data presented in our brochures. Safe operation also depends upon proper installation, operation and routine maintenance and inspection under prevailing conditions and recommendations set forth by ZF. Damage to transmission caused by repeated or continuous emergency manoeuvres or abnormal operation is not covered under warranty. It is the responsibility of users and not ZF to provide and install guards and safety devices, which may be required by recognized safety standards of the respective country (e.g. for U.S.A. the Occupational Safety Act of 1970 and its subsequent provisions).

Monitoring Notice

The safe operation of ZF products depends upon adherence to ZF monitoring recommendations presented in our operating manuals, etc. It is the responsibility of users and not ZF to provide and install monitoring devices and safety interlock systems as may be deemed prudent by ZF. Consult ZF for details and recommendations.

Torsional Responsibility and Torsional Couplings

The responsibility for ensuring torsional compatibility rests with the assembler of the drive and driven equipment. ZF can accept no liability for gearbox noise caused by vibrations or for damage to the gearbox, the flexible coupling or to other parts of the drive unit caused by this kind of vibration. Contact ZF for further information and assistance. ZF recommends the use of a torsional limit stop for single engine powered boats, wherein loss of propulsion power can result in loss of control. It is the buyer's responsibility to specify this option, which can result in additional cost and a possible increase in installation length.

ZF can accept no liability for personal injury, loss of life, or damage or loss of property due to the failure of the buyer to specify a torsional limit stop. ZF selects torsional couplings on the basis of nominal input torque ratings and commonly accepted rated engine governed speeds. Consult ZF for details concerning speed limits of standard offering torsional couplings, which can be less than the transmission limit. Special torsional couplings may be required for Survey Society Ice Classification requirements.