



ZF 286

Vertical offset, direct mount marine transmission.

Description

- Reverse reduction marine transmission with hydraulically actuated multi-disc clutches .
- Suitable for high performance applications in luxury motoryachts, sport fishers, express cruisers etc .
- Robust design also withstands continuous duty in workboat applications .
- Fully works tested, reliable and simple to install .
- Compatible with all types of engines and propulsion systems, including waterjets and surface- piercing propellers, as applicable .
- Design, manufacture and quality control standards comply with ISO 9001 .

Features

- Lightweight and robust aluminum alloy casing (sea water resistant) .
- Case hardened and precisely ground gear teeth for long life and smooth running .
- Output shaft thrust bearing designed to take maximum propeller thrust astern and ahead .
- Smooth and reliable hydraulic shifting with control lever for attachment of push-pull cable .
- Suitable for twin engine installations (same ratio and torque capacity in ahead or astern mode) .
- Replaceable oil filter cartridge .
- "SUPERSHIFT" clutch control .

Options

- SAE 1, SAE 2 and SAE 3 bell housings .
- Oil cooler complete with fittings and flexible oil hoses .
- Engine-matched torsional coupling .
- Mounting brackets .
- Propeller shaft flange and coupling bolt sets .
- Electric clutch control (12 or 24 VDC) .
- PTO (live) .
- Classification by all major Classification Societies on request .
- Mechanical or Electrical Trolling Valve for slow-speed drive .

ZF 286

Ratings

Pleasure Duty

RATIOS	MAX. TORQUE		POWER/RPM		INPUT POWER CAPACITY						MAX. RPM
	Nm	ftlb	kW	hp	2500 rpm		2800 rpm		3300 rpm		
					kW	hp	kW	hp	kW	hp	
1.237, 1.400, 1.500, 1.774, 1.966	1638	1208	0.1715	0.2300	429	575	480	644	566	759	3300
0.923, 1.000, 2.269	1567	1156	0.1641	0.2200	410	550	459	616	541	726	3300
2.481	1438	1061	0.1506	0.2019	376	505	422	565	497	666	3300
2.917	1239	914	0.1297	0.1740	324	435	363	487	428	574	3300

* Special Order Ratio.

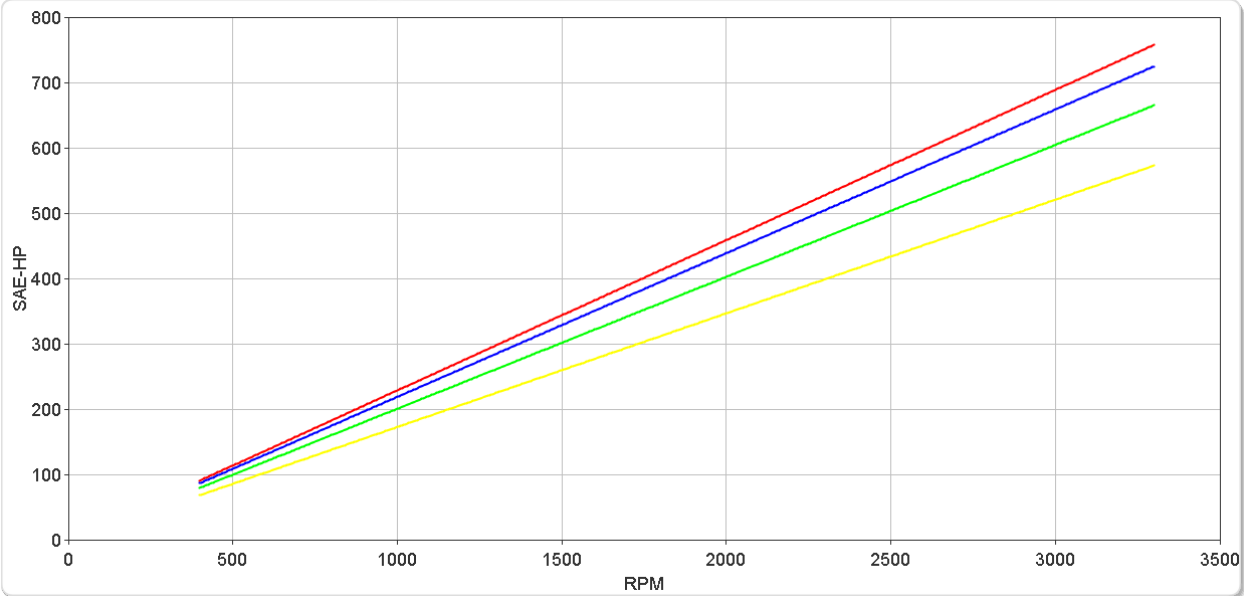
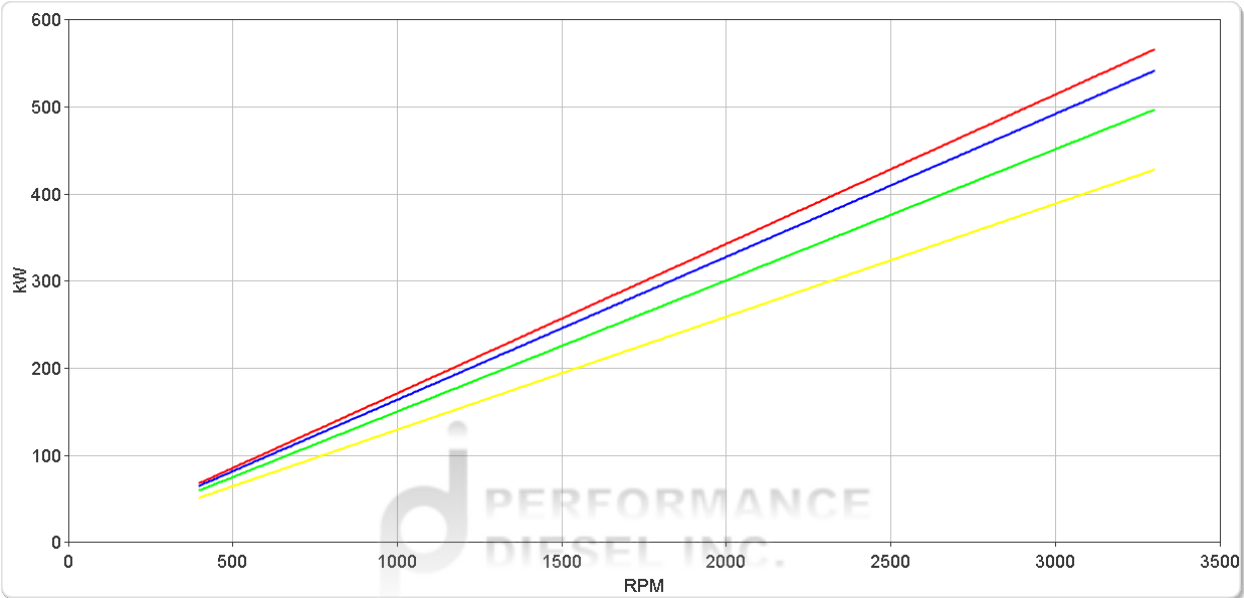

ZF 286

Ratings

Light Duty

RATIOS	MAX. TORQUE		POWER/RPM		INPUT POWER CAPACITY						MAX. RPM
	Nm	ftlb	kW	hp	2100 rpm		2500 rpm		2800 rpm		
					kW	hp	kW	hp	kW	hp	
1.237, 1.400, 1.500, 1.774, 1.966, 2.269	1475	1088	0.1545	0.2071	324	435	386	518	432	580	3300
0.923, 1.000	1424	1050	0.1491	0.2000	313	420	373	500	418	560	3300
2.481	1310	966	0.1372	0.1840	288	386	343	460	384	515	3300
2.917	1139	840	0.1193	0.1599	250	336	298	400	334	448	3300

* Special Order Ratio.

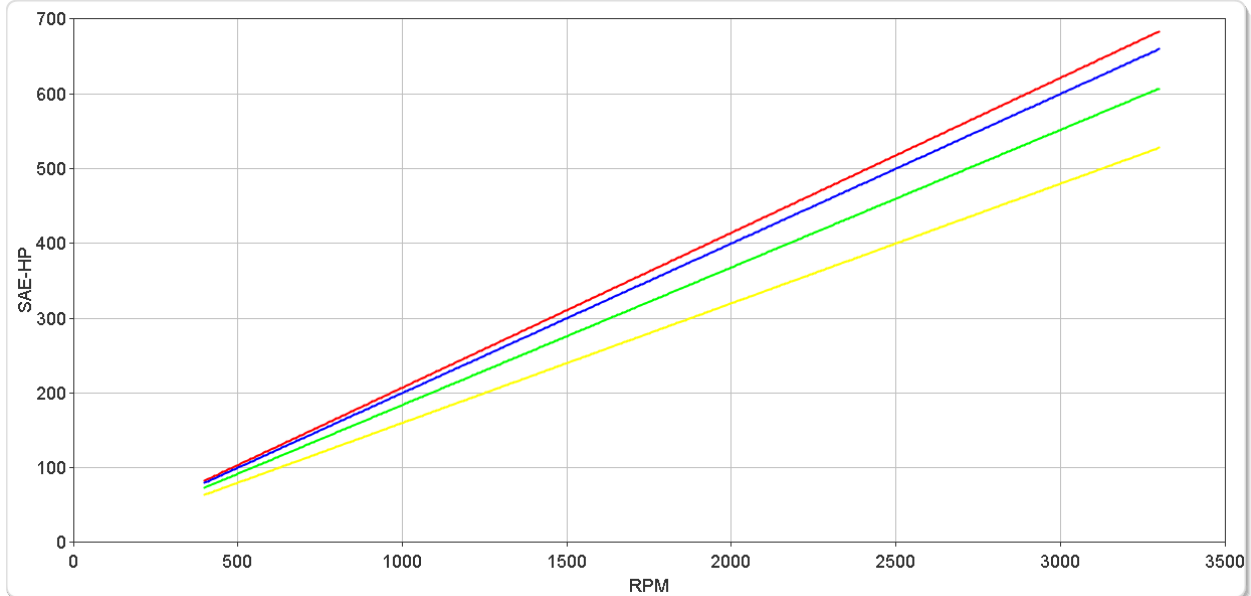

ZF 286

Ratings

Medium Duty

RATIOS	MAX. TORQUE		POWER/RPM		INPUT POWER CAPACITY						MAX. RPM
	Nm	ftlb	kW	hp	2100 rpm		2500 rpm		2800 rpm		
					kW	hp	kW	hp	kW	hp	
1.237, 1.400, 1.500, 1.774, 1.966, 2.269	1100	811	0.1152	0.1545	242	324	288	386	323	432	3300
0.923, 1.000, 2.481	1006	742	0.1053	0.1413	221	297	263	353	295	396	3300
2.917	916	676	0.0959	0.1286	201	270	240	322	269	360	3300

* Special Order Ratio.

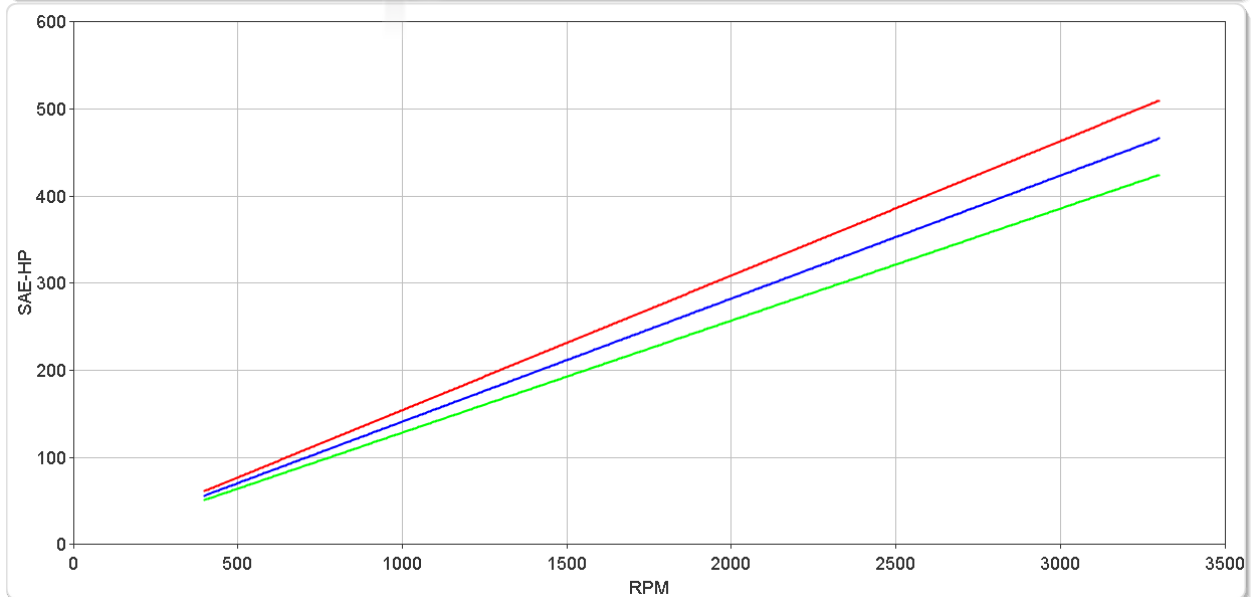
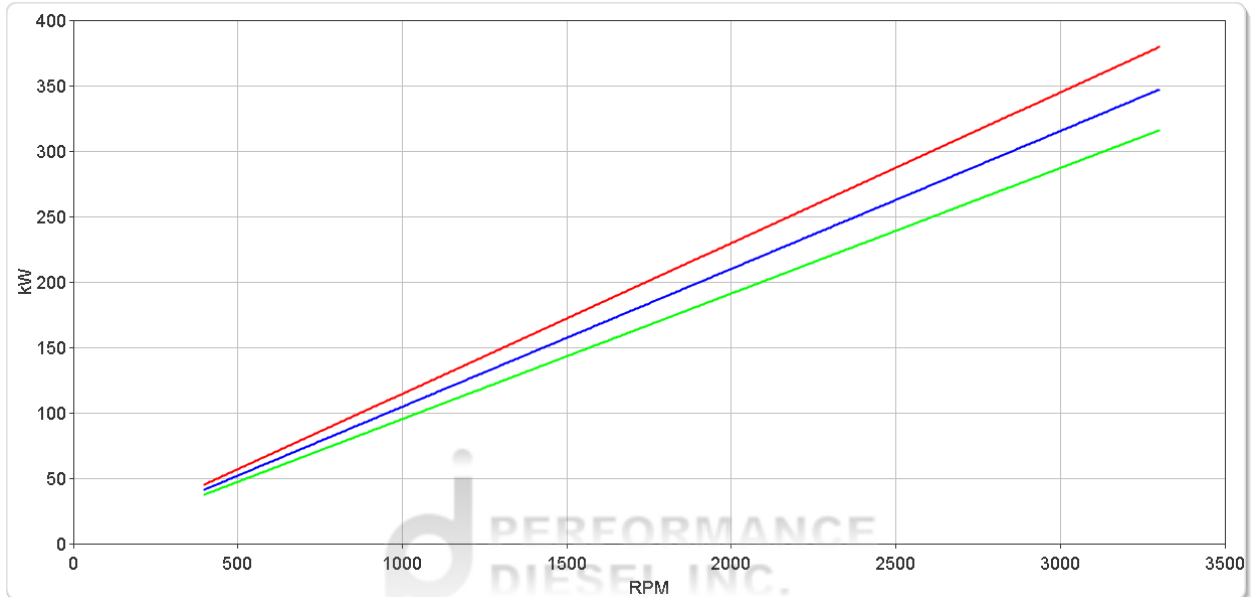

ZF 286

Ratings

Continuous Duty

RATIOS	MAX. TORQUE		POWER/RPM		INPUT POWER CAPACITY						MAX. RPM
	Nm	ftlb	kW	hp	1800 rpm		2100 rpm		2300 rpm		
					kW	hp	kW	hp	kW	hp	
1.237, 1.400, 1.500, 1.774, 1.966, 2.269	1000	738	0.1047	0.1404	188	253	220	295	241	323	3300
0.923, 1.000, 2.481	916	676	0.0959	0.1286	173	232	201	270	221	296	3300
2.917	836	617	0.0875	0.1174	158	211	184	247	201	270	3300

* Special Order Ratio.

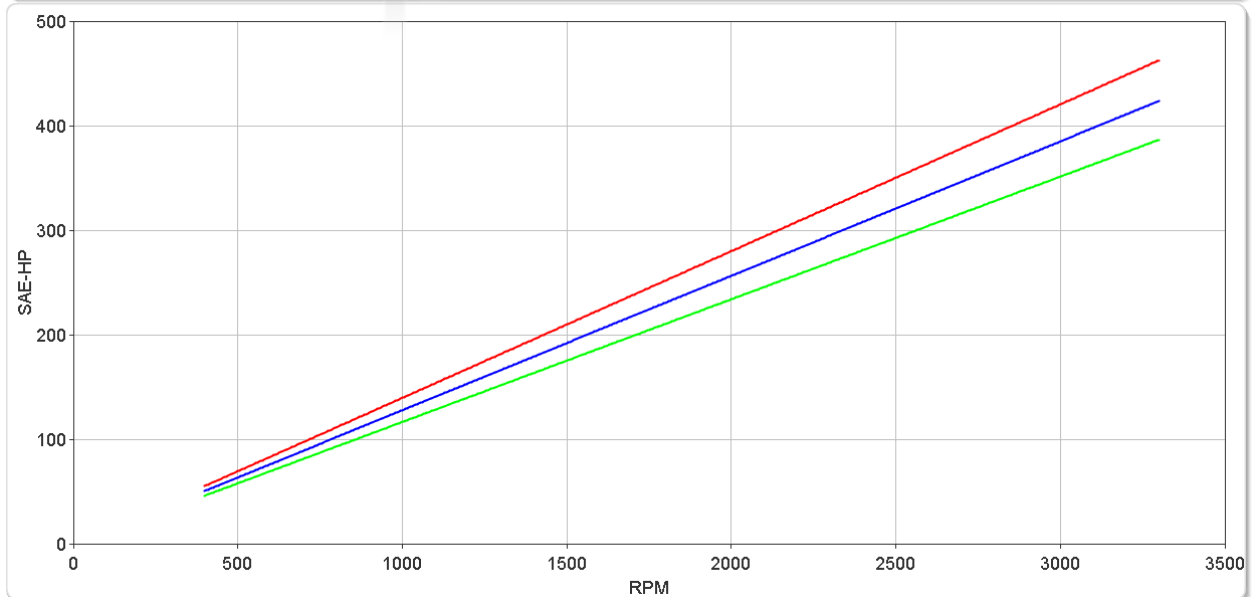
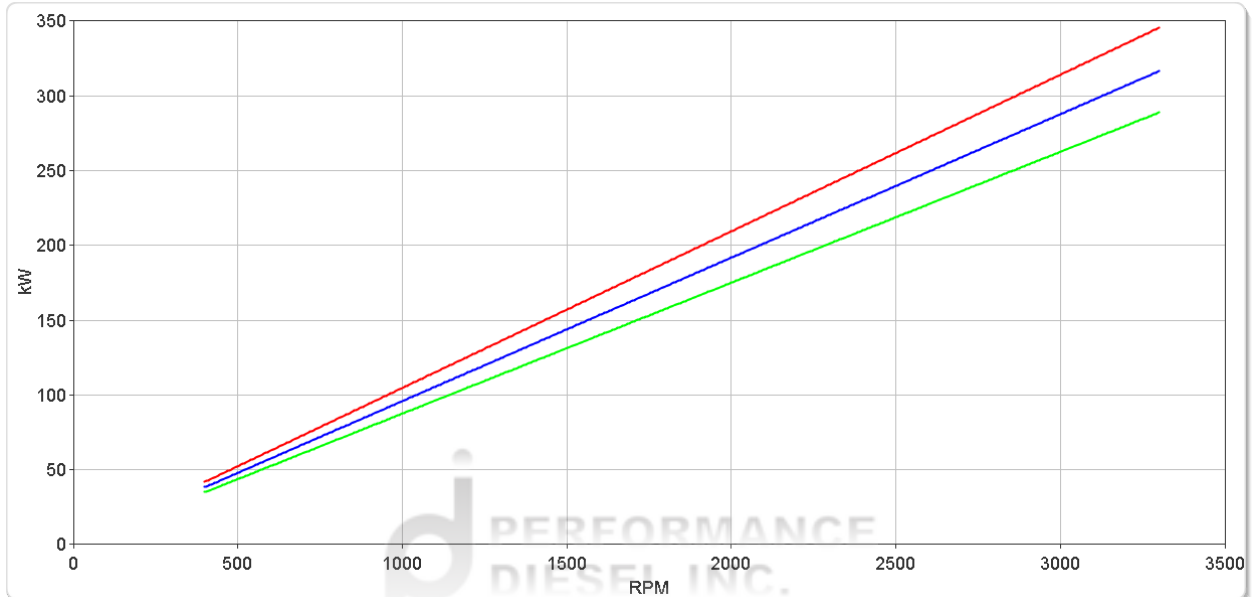

ZF 286

Dimensions

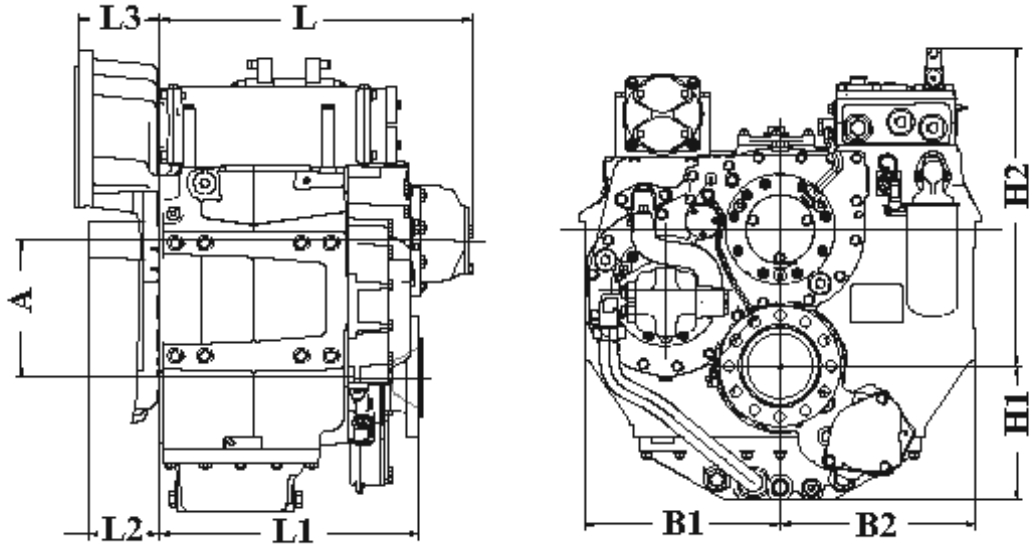

mm (inches)										Bell Hsg.
A	B ₁	B ₂	H ₁	H ₂	L	L ₁	L ₂	L ₃		
146 (5.75)	230 (9.06)	230 (9.06)	150 (5.91)	315 (12.4)	457 (18.0)	316 (12.4)	55.0 (2.17)	34.5 (1.36)		
Weight kg (lb)					Oil Capacity Litre (US qt)					
86.0 (189)					5.30 (5.60)					

SAE Bell Housing Dimensions

SAE No.	A		B		C		Bolt Holes		
	mm	in	mm	in	mm	in	No.	Diameter	
	mm	in	mm	in	mm	in	No.	mm	in
1	511.18	20.125	530.23	20.875	552.45	21.75	12	11.91	15/32
2	447.68	17.625	466.73	18.375	488.95	19.25	12	10.32	13/32
3	409.58	16.125	428.63	16.875	450.85	17.75	12	10.32	13/32

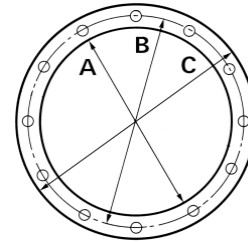

Output Coupling Dimensions

A		B		C		D		Bolt Holes		
mm	in	mm	in	mm	in	mm	in	No.	Diameter (E)	
mm	in	mm	in	mm	in	mm	in	No.	mm	in
146	5.75	121	4.75	76.2	3.00	14.0	0.55	6	16.2	0.64

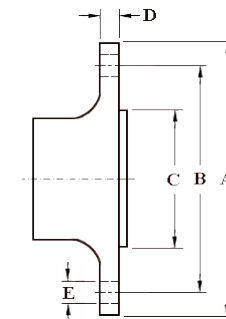

Duty Definitions

PLEASURE DUTY DEFINITION	Highly intermittent operation with very large variations in engine speed and power
Average engine operating hours limit:	500 hours/year 300 hours/year for mechanical gearboxes
Typical hull forms:	Planing.
Typical applications:	Private, non-commercial, non-charter sport/leisure activities.
LIGHT DUTY DEFINITION	Intermittent operation with large variations in engine speed and power
Average engine operating hours limit:	2500 hours/year (for hydraulic gearboxes smaller than the ZF 650 series, 2000 hours/year).
Typical hull forms:	Planing and semi-displacement.
Typical applications:	Private and charter, sport/leisure activities, naval and police activities.
MEDIUM DUTY DEFINITION	Intermittent operation with some variations in engine speed and power
Average engine operating hours limit:	4000 hours/year. 3500 hours/year for gearboxes smaller than ZF 2000 series and workboat ZF W2700 series.
Typical hull forms:	Semi-displacement and displacement
Typical applications:	Charter and commercial craft (example: crew boats and fast ferries), and naval and police activities.
CONTINUOUS DUTY DEFINITION	Continuous operation with little or no variations in engine speed and power
Average engine operating hours limit:	Unlimited
Typical hull forms:	Displacement.
Typical applications:	Heavy duty commercial vessels, tugs, fishing boats.

Duty Ratings

Ratings apply to marine diesel engines at the indicated speeds. At other engine speeds, the respective power capacity (kW) of the transmission can be obtained by multiplying the Power/Speed ratio by the speed.

Approximate conversion factors:

1 kW = 1.36 metric hp

1 kW = 1.34 U.S. hp (SAE)

1 U.S. hp = 1.014 metric hp

1 Nm = 0.74 lb.ft.

Ratings apply to right hand turning engines, i.e. engines having counterclockwise rotating flywheels when viewing the flywheel end of the engine.

These ratings allow full power through forward and reverse gear trains, unless otherwise stated.

Contact your nearest ZF Sales and Service office for ratings applicable to gas turbines, gasoline (petrol) engines, as well as left hand turning engines, and marine transmissions for large horsepower capacity engines.

Ratings apply to marine transmissions currently in production or in development and are subject to change without prior notice.

NOTE: THE MAXIMUM RATED INPUT POWER MUST NOT BE EXCEEDED (SEE RESPECTIVE RATINGS IN THE TECHNICAL DATA SHEETS)

Safe Operating Notice

The safe operation of ZF products depends upon adherence to technical data presented in our brochures. Safe operation also depends upon proper installation, operation and routine maintenance and inspection under prevailing conditions and recommendations set forth by ZF. Damage to transmission caused by repeated or continuous emergency manoeuvres or abnormal operation is not covered under warranty. It is the responsibility of users and not ZF to provide and install guards and safety devices, which may be required by recognized safety standards of the respective country (e.g. for U.S.A. the Occupational Safety Act of 1970 and its subsequent provisions).

Monitoring Notice

The safe operation of ZF products depends upon adherence to ZF monitoring recommendations presented in our operating manuals, etc. It is the responsibility of users and not ZF to provide and install monitoring devices and safety interlock systems as may be deemed prudent by ZF. Consult ZF for details and recommendations.

Torsional Responsibility and Torsional Couplings

The responsibility for ensuring torsional compatibility rests with the assembler of the drive and driven equipment. ZF can accept no liability for gearbox noise caused by vibrations or for damage to the gearbox, the flexible coupling or to other parts of the drive unit caused by this kind of vibration. Contact ZF for further information and assistance. ZF recommends the use of a torsional limit stop for single engine powered boats, wherein loss of propulsion power can result in loss of control. It is the buyer's responsibility to specify this option, which can result in additional cost and a possible increase in installation length.

ZF can accept no liability for personal injury, loss of life, or damage or loss of property due to the failure of the buyer to specify a torsional limit stop. ZF selects torsional couplings on the basis of nominal input torque ratings and commonly accepted rated engine governed speeds. Consult ZF for details concerning speed limits of standard offering torsional couplings, which can be less than the transmission limit. Special torsional couplings may be required for Survey Society Ice Classification requirements.