



ZF 30050 NR2

Vertical offset, remote mount marine transmission.

Description

- 2 shaft non reverse reduction transmission for waterjet applications and ccp`s.
- Input shaft vertical above the output shaft.
- Hydraulic clutch mounted on the input shaft.
- Fully works tested, reliable and simple to install .
- Suitable for heavy duty fast ferry applications. Also suitable for other weight sensitive craft, e.g. high speed motor yachts .
- Design, manufacture and quality control standards comply with ISO 9001 and AQAP .
- Compatible with all types of engines.
- Compact, space-saving design, complete with oil cooler, pump and full flow filter.

Features

- Lightweight cast aluminum alloy housing resistant to sea water corrosion. .
- Case hardened and precisely ground gear teeth for long life and smooth running .
- Smooth and reliable hydraulic shifting with electric actuation .
- Suitable for multi engine installations.
- Airborn and structure born noise in accordance to ISO 8579 .

Options

- Classification by all major Classification Societies on request .
- Engine-matched torsional coupling .
- Input flange .
- Monitoring kit .
- Mounting brackets .
- Trailing pump .
- One power take off (PTO) drive with SAE connection, permanently connected and driven from the input shaft. .



ZF 30050 NR2

Ratings

Light Duty

RATIOS	MAX. TORQUE		POWER/RPM		INPUT POWER CAPACITY						MAX. RPM
	Nm	ftlb	kW	hp	1800 rpm		2000 rpm		2100 rpm		
1.514*, 1.735, 1.906, 2.032, 2.207*	33159	24457	3.4721	4.6562	6250	8381	6944	9312	7292	9778	2300

* Special Order Ratio.

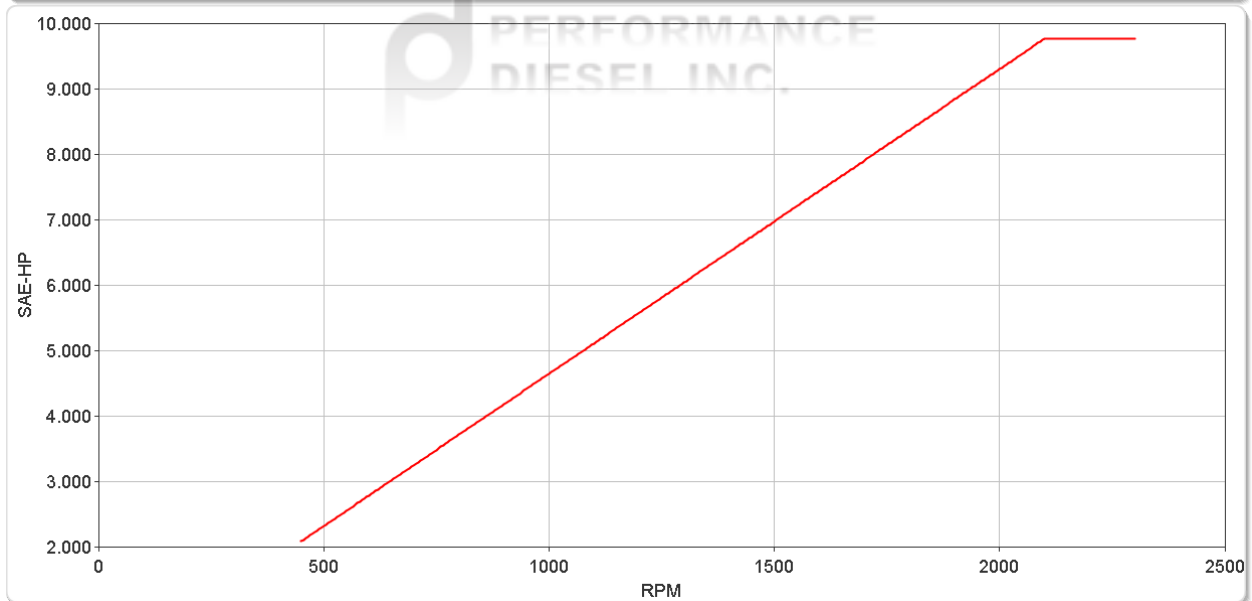
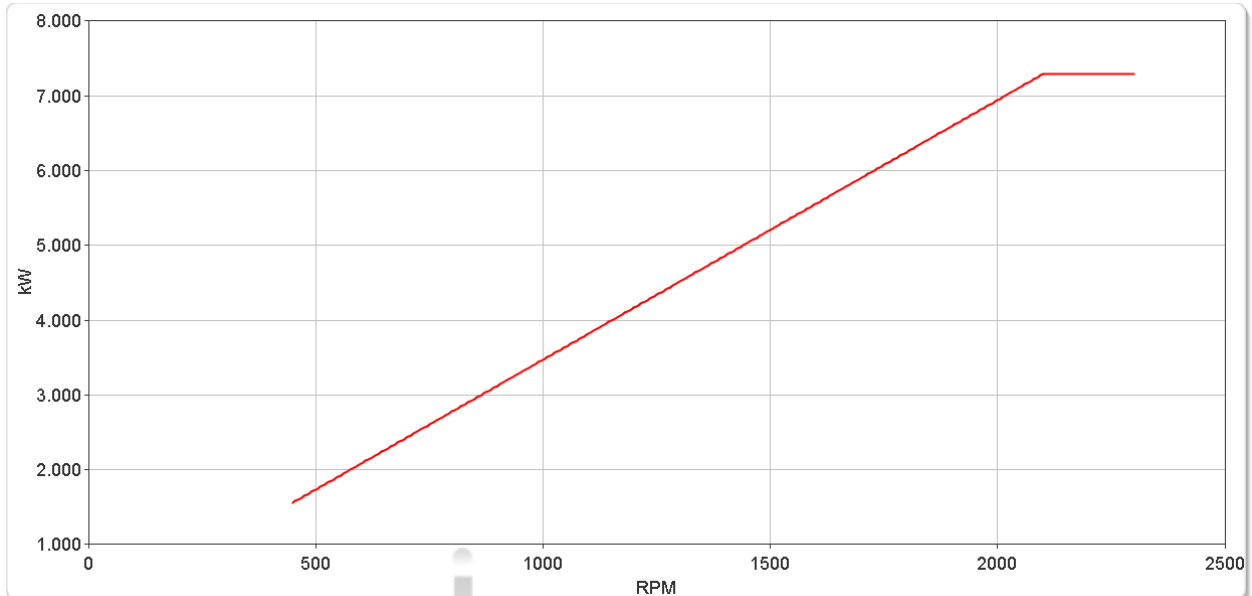

ZF 30050 NR2

Ratings

Medium Duty

RATIOS	MAX. TORQUE		POWER/RPM		INPUT POWER CAPACITY						MAX. RPM
	Nm	ftlb	kW	hp	1600 rpm		1800 rpm		2000 rpm		
1.514*, 1.735, 1.906, 2.032, 2.207*	28068	20702	2.9391	3.9413	4702	6306	5290	7094	5878	7883	2300

* Special Order Ratio.

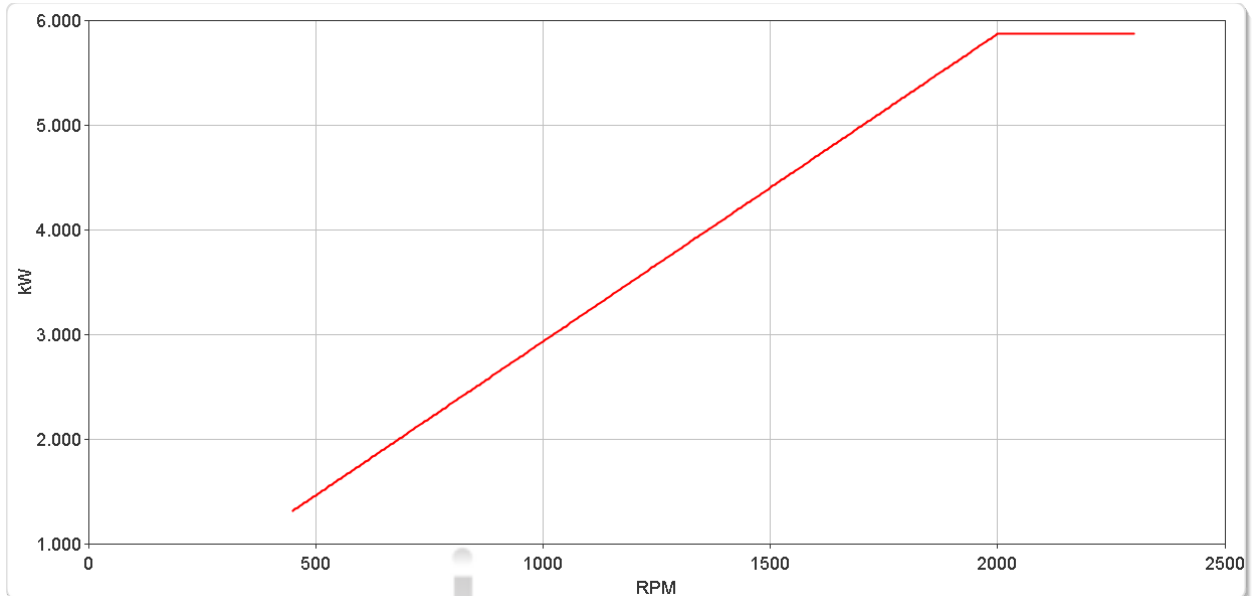

ZF 30050 NR2

Ratings

Continuous Duty

RATIOS	MAX. TORQUE		POWER/RPM		INPUT POWER CAPACITY						MAX. RPM
	Nm	ftlb	kW	hp	1200 rpm		1600 rpm		1800 rpm		
1.514*, 1.735, 1.906, 2.032, 2.207*	22193	16369	2.3239	3.1164	2789	3740	3718	4986	4183	5609	1800

* Special Order Ratio.

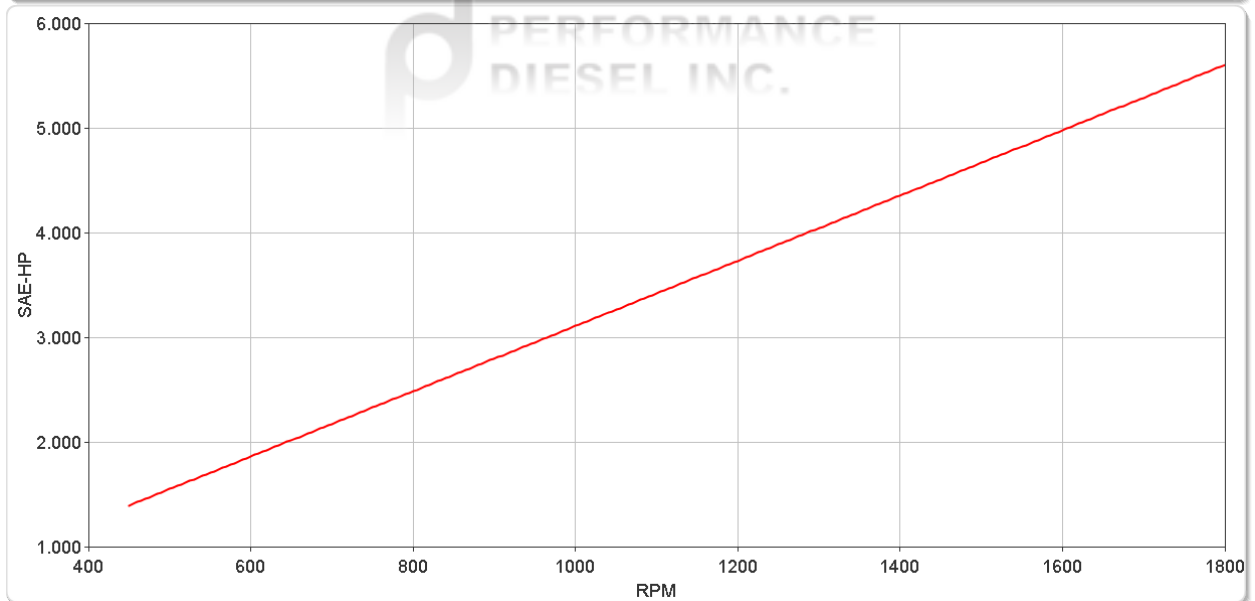
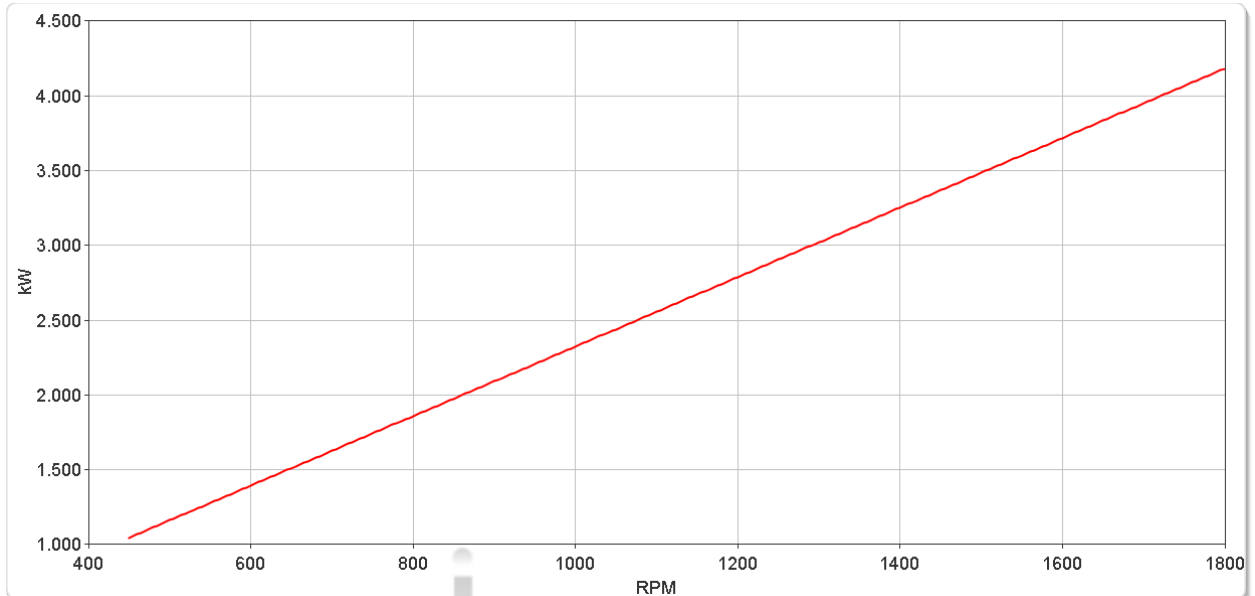

ZF 30050 NR2

Dimensions

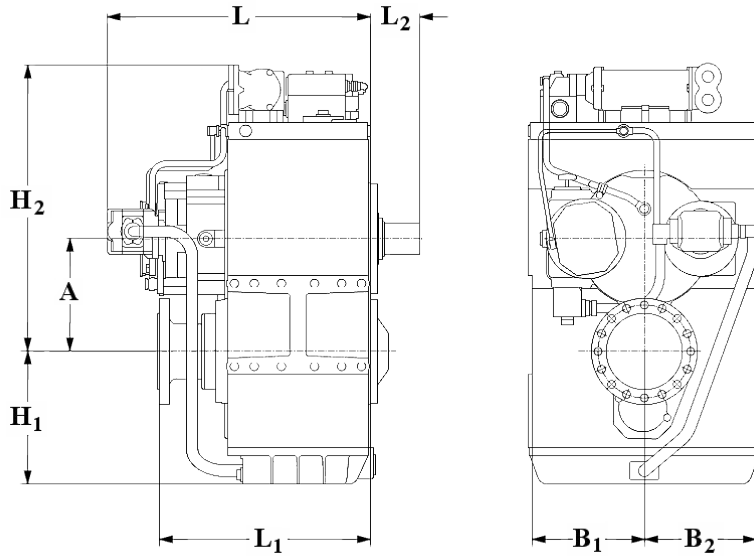

mm (inches)							
A	B ₁	B ₂	H ₁	H ₂	L	L ₁	L ₂
475 (18.7)	455 (17.9)	455 (17.9)	480 (18.9)	1,072 (42.2)	1,032 (40.6)	750 (29.5)	480 (18.9)
Weight kg (lb)				Oil Capacity Litre (US qt)			
1,640 (3,608)				75.0 (80.0)			

Output Coupling Dimensions

A		B		C		D		No.	Bolt Holes Diameter (E)	
mm	in	mm	in	mm	in	mm	in		mm	in
435	17.1	385	15.2	330	13.0	46.0	1.81	20	30.4	1.20

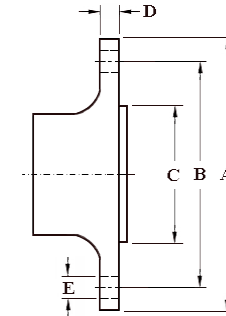

Duty Definitions

LIGHT DUTY DEFINITION	Intermittent operation with large variations in engine speed and power
Average engine operating hours limit:	2500 hours/year (for hydraulic gearboxes smaller than the ZF 650 series, 2000 hours/year).
Typical hull forms:	Planing and semi-displacement.
Typical applications:	Private and charter, sport/leisure activities, naval and police activities.
MEDIUM DUTY DEFINITION	Intermittent operation with some variations in engine speed and power
Average engine operating hours limit:	4000 hours/year. 3500 hours/year for gearboxes smaller than ZF 2000 series and workboat ZF W2700 series.
Typical hull forms:	Semi-displacement and displacement
Typical applications:	Charter and commercial craft (example: crew boats and fast ferries), and naval and police activities.
CONTINUOUS DUTY DEFINITION	Continuous operation with little or no variations in engine speed and power
Average engine operating hours limit:	Unlimited
Typical hull forms:	Displacement.
Typical applications:	Heavy duty commercial vessels, tugs, fishing boats.

Duty Ratings

Ratings apply to marine diesel engines at the indicated speeds. At other engine speeds, the respective power capacity (kW) of the transmission can be obtained by multiplying the Power/Speed ratio by the speed.

Approximate conversion factors:

1 kW = 1.36 metric hp

1 kW = 1.34 U.S. hp (SAE)

1 U.S. hp = 1.014 metric hp

1 Nm = 0.74 lb.ft.

Ratings apply to right hand turning engines, i.e. engines having counterclockwise rotating flywheels when viewing the flywheel end of the engine.

These ratings allow full power through forward and reverse gear trains, unless otherwise stated.

Contact your nearest ZF Sales and Service office for ratings applicable to gas turbines, gasoline (petrol) engines, as well as left hand turning engines, and marine transmissions for large horsepower capacity engines.

Ratings apply to marine transmissions currently in production or in development and are subject to change without prior notice.

NOTE: THE MAXIMUM RATED INPUT POWER MUST NOT BE EXCEEDED (SEE RESPECTIVE RATINGS IN THE TECHNICAL DATA SHEETS)

Safe Operating Notice

The safe operation of ZF products depends upon adherence to technical data presented in our brochures. Safe operation also depends upon proper installation, operation and routine maintenance and inspection under prevailing conditions and recommendations set forth by ZF. Damage to transmission caused by repeated or continuous emergency manoeuvres or abnormal operation is not covered under warranty. It is the responsibility of users and not ZF to provide and install guards and safety devices, which may be required by recognized safety standards of the respective country (e.g. for U.S.A. the Occupational Safety Act of 1970 and its subsequent provisions).

Monitoring Notice

The safe operation of ZF products depends upon adherence to ZF monitoring recommendations presented in our operating manuals, etc. It is the responsibility of users and not ZF to provide and install monitoring devices and safety interlock systems as may be deemed prudent by ZF. Consult ZF for details and recommendations.

Torsional Responsibility and Torsional Couplings

The responsibility for ensuring torsional compatibility rests with the assembler of the drive and driven equipment. ZF can accept no liability for gearbox noise caused by vibrations or for damage to the gearbox, the flexible coupling or to other parts of the drive unit caused by this kind of vibration. Contact ZF for further information and assistance. ZF recommends the use of a torsional limit stop for single engine powered boats, wherein loss of propulsion power can result in loss of control. It is the buyer's responsibility to specify this option, which can result in additional cost and a possible increase in installation length.

ZF can accept no liability for personal injury, loss of life, or damage or loss of property due to the failure of the buyer to specify a torsional limit stop. ZF selects torsional couplings on the basis of nominal input torque ratings and commonly accepted rated engine governed speeds. Consult ZF for details concerning speed limits of standard offering torsional couplings, which can be less than the transmission limit. Special torsional couplings may be required for Survey Society Ice Classification requirements.