

ZF 30350 SG

Near co-axial, remote mount marine transmission.

Description

- Reverse reduction marine transmission with hydraulical clutches. Input drive on opposite side to output drive.
- Non-reversing NR version also available .
- Fully works tested, reliable and simple to install .
- Suitable for high performance applications in all types of fast craft, luxury motoryachts, patrol vessels, crew-boats etc .
- Design, manufacture and quality control standards comply with ISO 9001 and AQAP .
- Compatible with all types of engines and propulsion systems, including waterjets and surface-piercing propellers and CPPs .
- Vertical offset, nearly coaxial design .

Features

- Lightweight and robust aluminum alloy casing (sea water resistant) .
- Case hardened and precisely ground gear teeth for long life and smooth running .
- Output shaft thrust bearing designed to take maximum propeller thrust astern and ahead .
- Smooth and reliable hydraulic shifting with electric actuation .
- Compact, space-saving design, complete with oil cooler, pump and full flow filter .
- Suitable for multi engine installation (same ratio and torque capacity engine-wise or counter engine-wise) .

Options

- Engine-matched torsional coupling .
- Propeller shaft flange and coupling bolt sets .
- Classification by all major Classification Societies on request .
- Monitoring kit .
- Elastic mounting brackets .
- PTO (live) .
- ZF-Autotroll electronic control system for slow-speed drive .

ZF 30350 SG

Ratings

Light Duty

| RATIOS | MAX. TORQUE | | POWER/RPM | | INPUT POWER CAPACITY | | | | | | MAX. RPM |
|--------------|-------------|-------|-----------|--------|----------------------|------|----------|------|----------|------|----------|
| | Nm | ftlb | kW | hp | 1200 rpm | | 1400 rpm | | 1600 rpm | | |
| 2.100, 4.600 | 33160 | 24458 | 3.4723 | 4.6564 | 4167 | 5588 | 4861 | 6519 | 5556 | 7450 | 1600 |
| 4.900 | 30000 | 22127 | 3.1414 | 4.2126 | 3770 | 5055 | 4398 | 5898 | 5026 | 6740 | 1600 |

* Special Order Ratio.

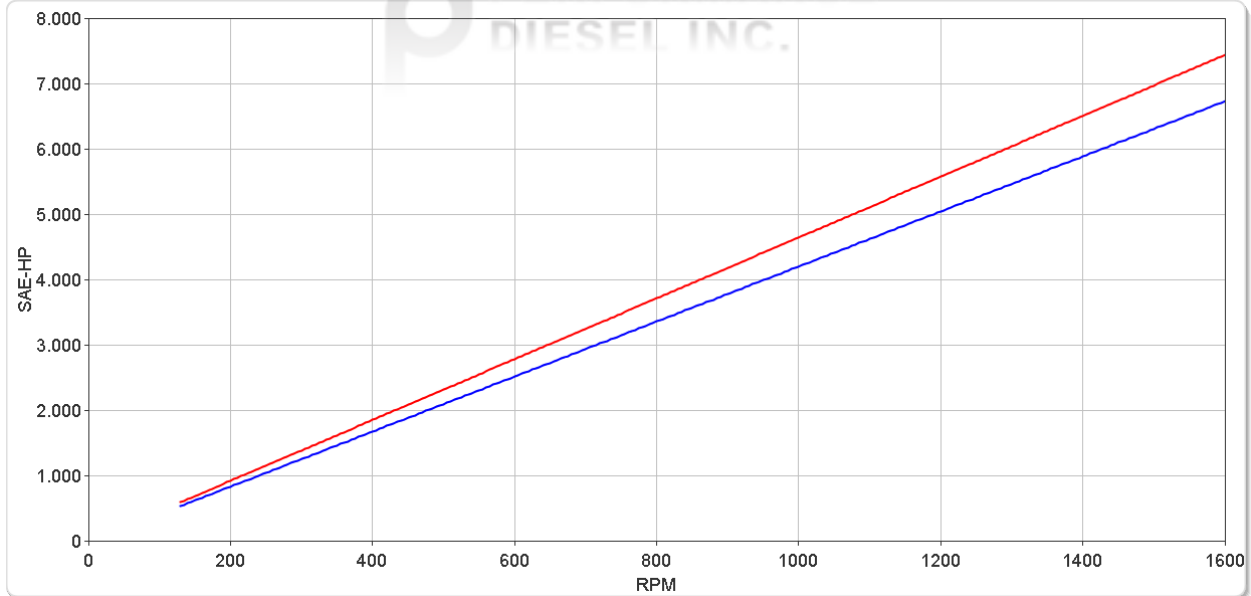
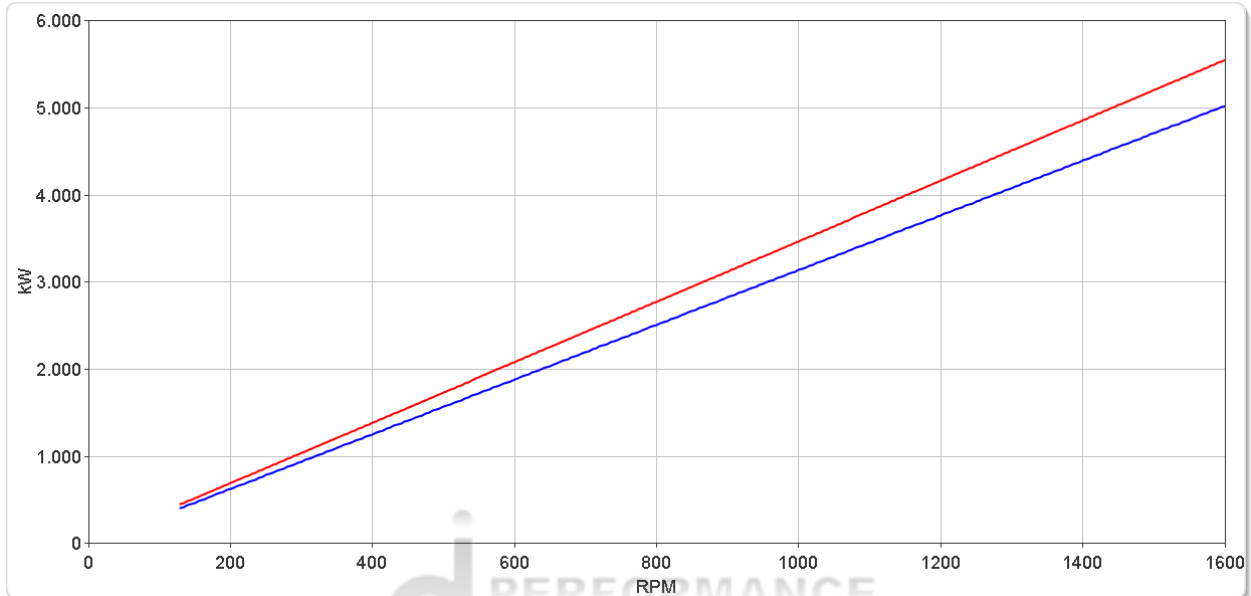

ZF 30350 SG

Ratings

Medium Duty

| RATIOS | MAX. TORQUE | | POWER/RPM | | INPUT POWER CAPACITY | | | | | | MAX. RPM |
|--------------|-------------|-------|-----------|--------|----------------------|------|----------|------|----------|------|----------|
| | Nm | ftlb | kW | hp | 1100 rpm | | 1300 rpm | | 1570 rpm | | |
| | | | | | kW | hp | kW | hp | kW | hp | |
| 2.100, 4.600 | 28067 | 20701 | 2.9390 | 3.9412 | 3233 | 4335 | 3821 | 5124 | 4614 | 6188 | 1570 |
| 4.900 | 25393 | 18729 | 2.6590 | 3.5657 | 2925 | 3922 | 3457 | 4635 | 4175 | 5598 | 1570 |

* Special Order Ratio.

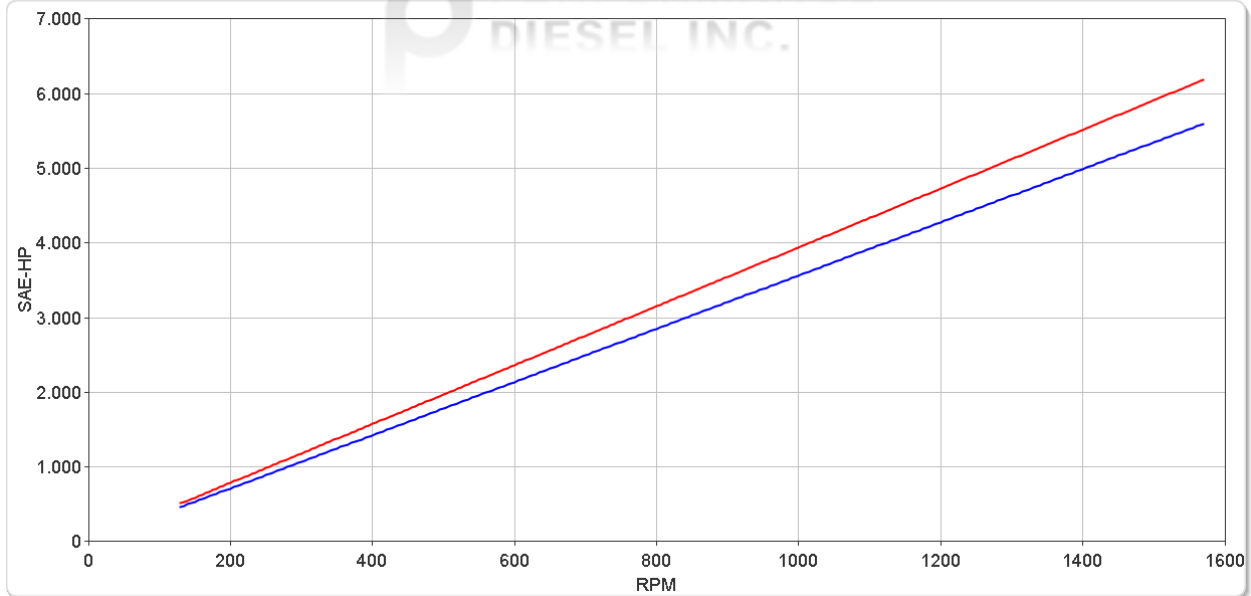
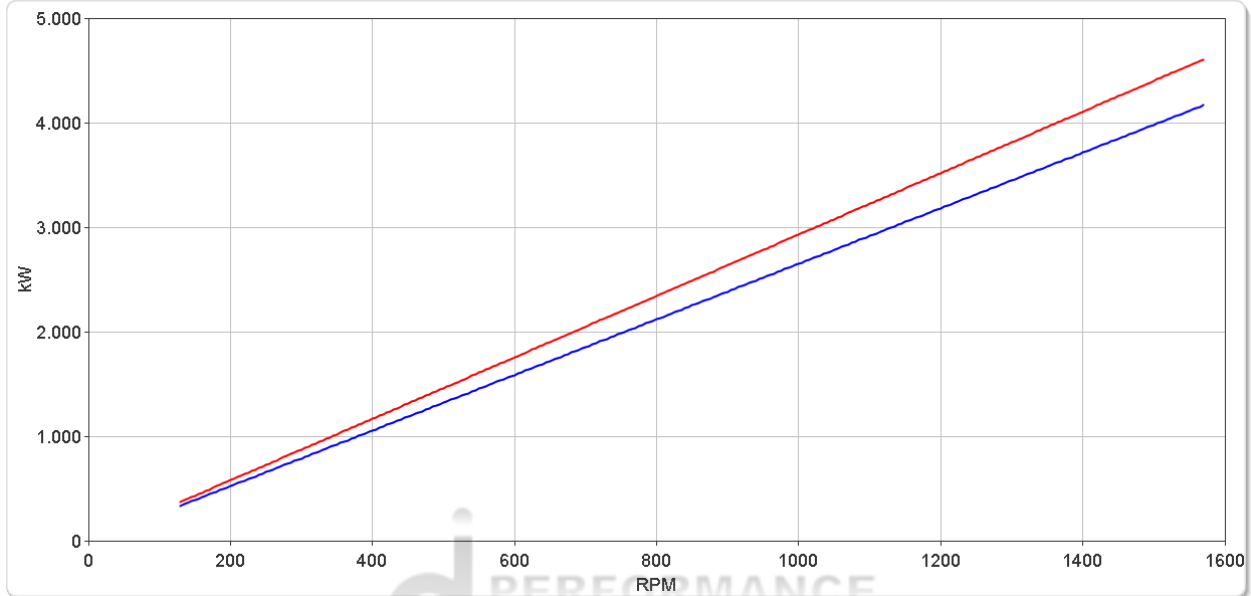

ZF 30350 SG

Ratings

Continuous Duty

| RATIOS | MAX. TORQUE | | POWER/RPM | | INPUT POWER CAPACITY | | | | | | MAX. RPM |
|---|-------------|-------|-----------|--------|----------------------|------|----------|------|----------|------|----------|
| | Nm | ftlb | kW | hp | 1000 rpm | | 1200 rpm | | 1380 rpm | | |
| | | | | | kW | hp | kW | hp | kW | hp | |
| ■ 2.100, 4.600 | 22193 | 16369 | 2.3239 | 3.1164 | 2324 | 3116 | 2789 | 3740 | 3207 | 4301 | 1380 |
| ■ 4.900 | 20078 | 14809 | 2.1024 | 2.8194 | 2102 | 2819 | 2523 | 3383 | 2901 | 3891 | 1380 |

* Special Order Ratio.

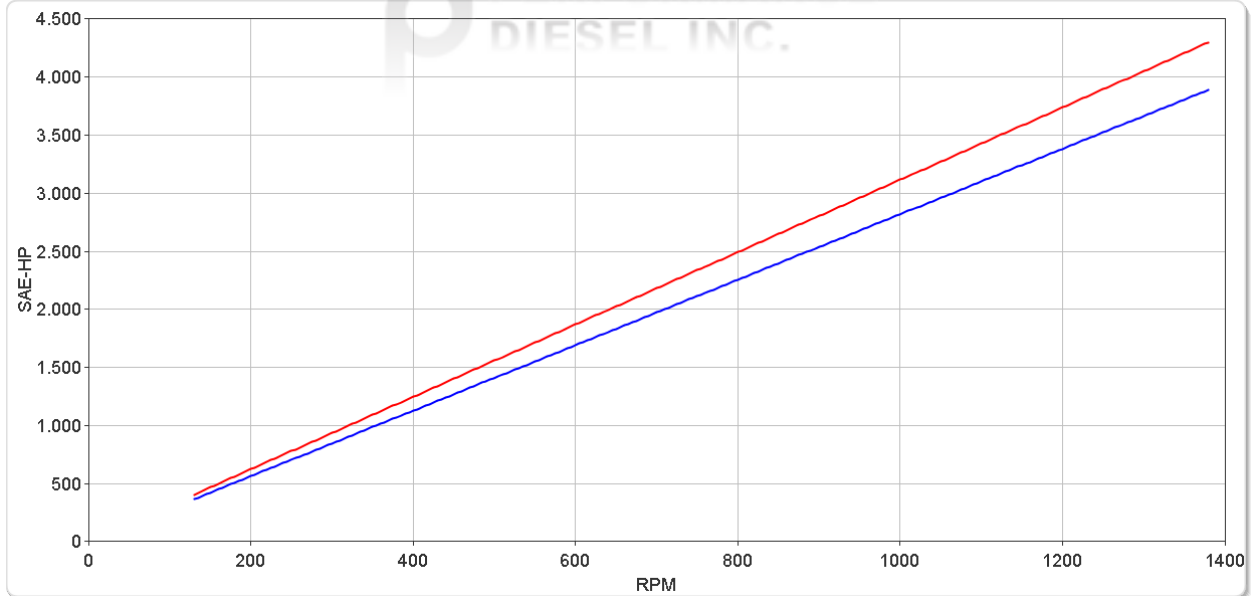
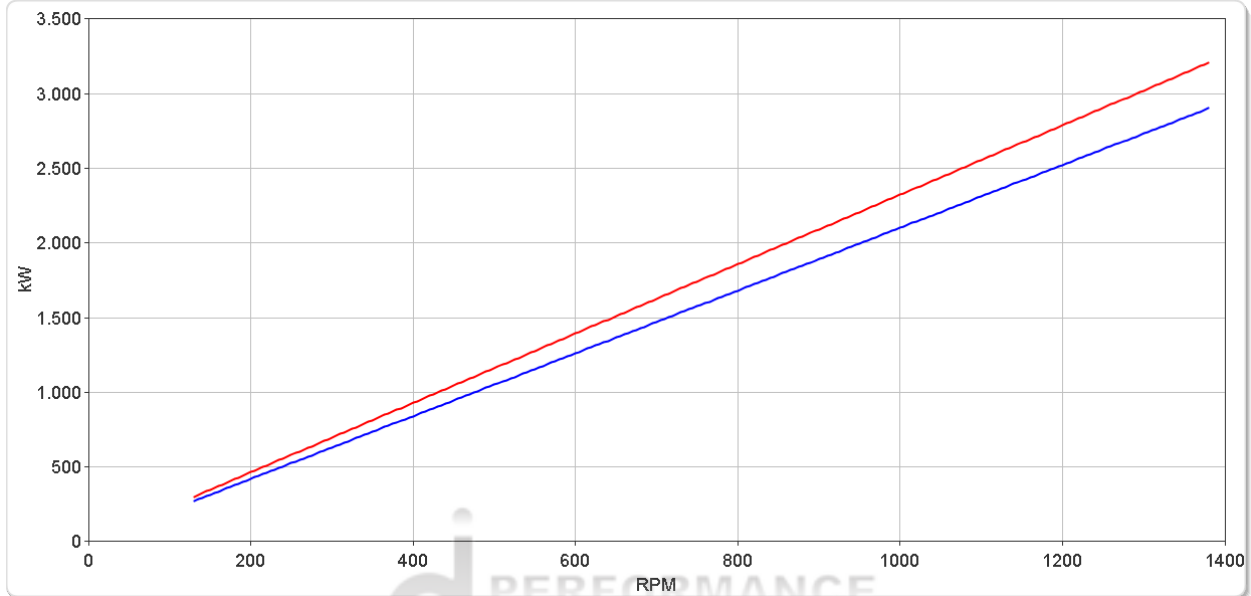

ZF 30350 SG

Dimensions

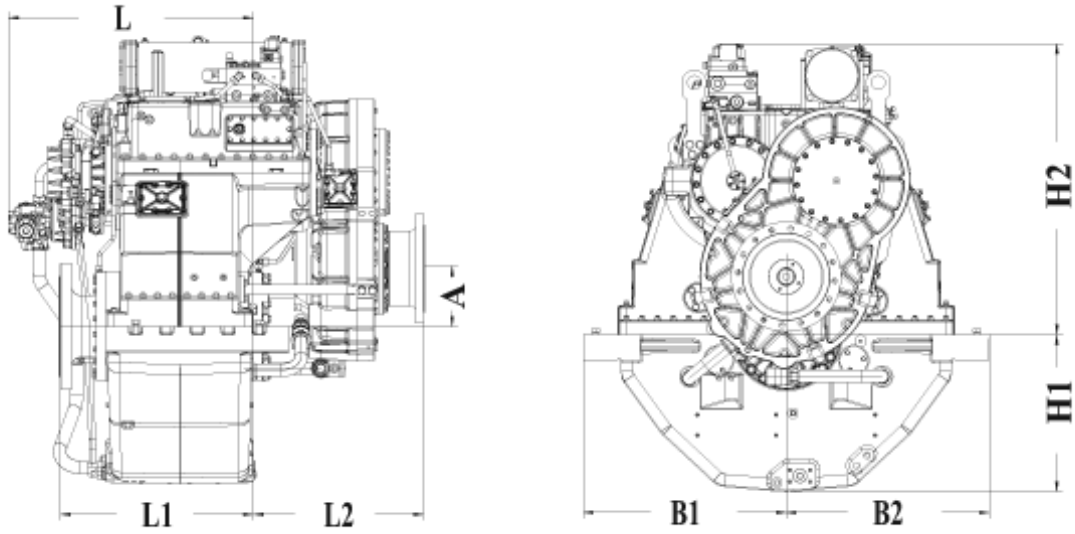

| mm (inches) | | | | | | | | | | |
|-----------------|----------------|----------------|----------------|----------------|----------------------------|----------------|--------------|----------------|----------------|--|
| A | B ₁ | B ₂ | B ₃ | B ₄ | H ₁ | H ₂ | L | L ₁ | L ₂ | |
| 254 (10.0) | 890 (35.1) | 890 (35.1) | - | - | 690 (27.2) | 1,288 (50.7) | 1,073 (42.2) | 845 (33.3) | 750 (29.5) | |
| Weight kg (lb) | | | | | Oil Capacity Litre (US qt) | | | | | |
| 4,575 (10,086) | | | | | 200 (212) | | | | | |

Output Coupling Dimensions

| A | | B | | C | | D | | No. | Bolt Holes Diameter (E) | |
|-----|------|-----|------|-----|------|------|------|-----|-------------------------|------|
| mm | in | mm | in | mm | in | mm | in | | mm | in |
| 550 | 21.7 | 492 | 19.4 | 437 | 17.2 | 50.0 | 1.97 | 24 | 30.4 | 1.20 |

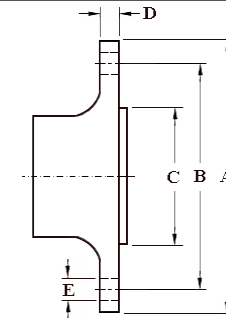

Duty Definitions

| | |
|---------------------------------------|---|
| LIGHT DUTY DEFINITION | Intermittent operation with large variations in engine speed and power |
| Average engine operating hours limit: | 2500 hours/year (for hydraulic gearboxes smaller than the ZF 650 series, 2000 hours/year). |
| Typical hull forms: | Planing and semi-displacement. |
| Typical applications: | Private and charter, sport/leisure activities, naval and police activities. |
| MEDIUM DUTY DEFINITION | Intermittent operation with some variations in engine speed and power |
| Average engine operating hours limit: | 4000 hours/year. 3500 hours/year for gearboxes smaller than ZF 2000 series and workboat ZF W2700 series. |
| Typical hull forms: | Semi-displacement and displacement |
| Typical applications: | Charter and commercial craft (example: crew boats and fast ferries), and naval and police activities. |
| CONTINUOUS DUTY DEFINITION | Continuous operation with little or no variations in engine speed and power |
| Average engine operating hours limit: | Unlimited |
| Typical hull forms: | Displacement. |
| Typical applications: | Heavy duty commercial vessels, tugs, fishing boats. |

Duty Ratings

Ratings apply to marine diesel engines at the indicated speeds. At other engine speeds, the respective power capacity (kW) of the transmission can be obtained by multiplying the Power/Speed ratio by the speed.
Approximate conversion factors:

1 kW = 1.36 metric hp

1 kW = 1.34 U.S. hp (SAE)

1 U.S. hp = 1.014 metric hp

1 Nm = 0.74 lb.ft.

Ratings apply to right hand turning engines, i.e. engines having counterclockwise rotating flywheels when viewing the flywheel end of the engine. These ratings allow full power through forward and reverse gear trains, unless otherwise stated. Contact your nearest ZF Sales and Service office for ratings applicable to gas turbines, gasoline (petrol) engines, as well as left hand turning engines, and marine transmissions for large horsepower capacity engines. Ratings apply to marine transmissions currently in production or in development and are subject to change without prior notice.
NOTE: THE MAXIMUM RATED INPUT POWER MUST NOT BE EXCEEDED (SEE RESPECTIVE RATINGS IN THE TECHNICAL DATA SHEETS)

Safe Operating Notice

The safe operation of ZF products depends upon adherence to technical data presented in our brochures. Safe operation also depends upon proper installation, operation and routine maintenance and inspection under prevailing conditions and recommendations set forth by ZF. Damage to transmission caused by repeated or continuous emergency manoeuvres or abnormal operation is not covered under warranty. It is the responsibility of users and not ZF to provide and install guards and safety devices, which may be required by recognized safety standards of the respective country (e.g. for U.S.A. the Occupational Safety Act of 1970 and its subsequent provisions).

Monitoring Notice

The safe operation of ZF products depends upon adherence to ZF monitoring recommendations presented in our operating manuals, etc. It is the responsibility of users and not ZF to provide and install monitoring devices and safety interlock systems as may be deemed prudent by ZF. Consult ZF for details and recommendations.

Torsional Responsibility and Torsional Couplings

The responsibility for ensuring torsional compatibility rests with the assembler of the drive and driven equipment. ZF can accept no liability for gearbox noise caused by vibrations or for damage to the gearbox, the flexible coupling or to other parts of the drive unit caused by this kind of vibration. Contact ZF for further information and assistance. ZF recommends the use of a torsional limit stop for single engine powered boats, wherein loss of propulsion power can result in loss of control. It is the buyer's responsibility to specify this option, which can result in additional cost and a possible increase in installation length.

ZF can accept no liability for personal injury, loss of life, or damage or loss of property due to the failure of the buyer to specify a torsional limit stop. ZF selects torsional couplings on the basis of nominal input torque ratings and commonly accepted rated engine governed speeds. Consult ZF for details concerning speed limits of standard offering torsional couplings, which can be less than the transmission limit. Special torsional couplings may be required for Survey Society Ice Classification requirements.