



## ZF 3050 D

Diagonal offset, remote mount marine transmission.

### Description

- 3 shaft, reverse reduction transmission with hydraulic clutch mounted on the input shaft and another one mounted on the reverse shaft. Input drive on opposite side to output drive.
- For main output direction "counter engine-wise" only. Engine-wise output rotation intended only for flashing the water jet .
- Non-reversing NR version for counter engine-wise output rotation also available.
- Fully works tested, reliable and simple to install .
- Suitable for high performance applications in all types of fast craft, luxury motoryachts, patrol vessels, crew-boats etc .
- Compact, space-saving design, complete with oil cooler, pump and full flow filter.
- Design, manufacture and quality control standards comply with ISO 9001 .

### Features

- Lightweight and robust aluminum alloy casing (sea water resistant) .
- Case hardened and precisely ground gear teeth for long life and smooth running .
- Smooth and reliable hydraulic shifting with electric actuation .
- Emergency "get home" capability .
- Suitable for twin engine installation (same ratio and torque capacity engine-wise or counter-engine-wise) .

### Options

- Engine-matched torsional coupling .
- Mounting brackets .
- Propeller shaft flange and coupling bolt sets .
- Input flange .
- Mechanical actuation with lever for attachment of push-pull cable .
- Monitoring kit .
- Live PTO's: Pump shaft driven, input shaft driven, TOP PTO .
- Trailing pump .
- Classification by all major Classification Societies on request .
- Trolling valve(electrical) .
- "AUTOTROLL" .

# ZF 3050 D

## Ratings

### Pleasure Duty

RATIOS	MAX. TORQUE		POWER/RPM		INPUT POWER CAPACITY						MAX. RPM
	Nm	ftlb	kW	hp	2100 rpm		2300 rpm		2450 rpm		
					kW	hp	kW	hp	kW	hp	
<span style="color: red;">■</span> 1.093*, 1.250*, 1.441*, 1.500, 1.563*, 1.645*, 1.700*, 1.733*, 1.800*, 1.828*, 2.037, 2.240*, 2.375*, 2.500, 2.609*, 2.773*, 2.952*	5888	4343	0.6165	0.8268	1295	1736	1418	1902	1511	2026	2600

\* Special Order Ratio.

D - transmissions only for counter engine wise rotation available (waterjet application). Reversing feature for cleaning the jet possible.

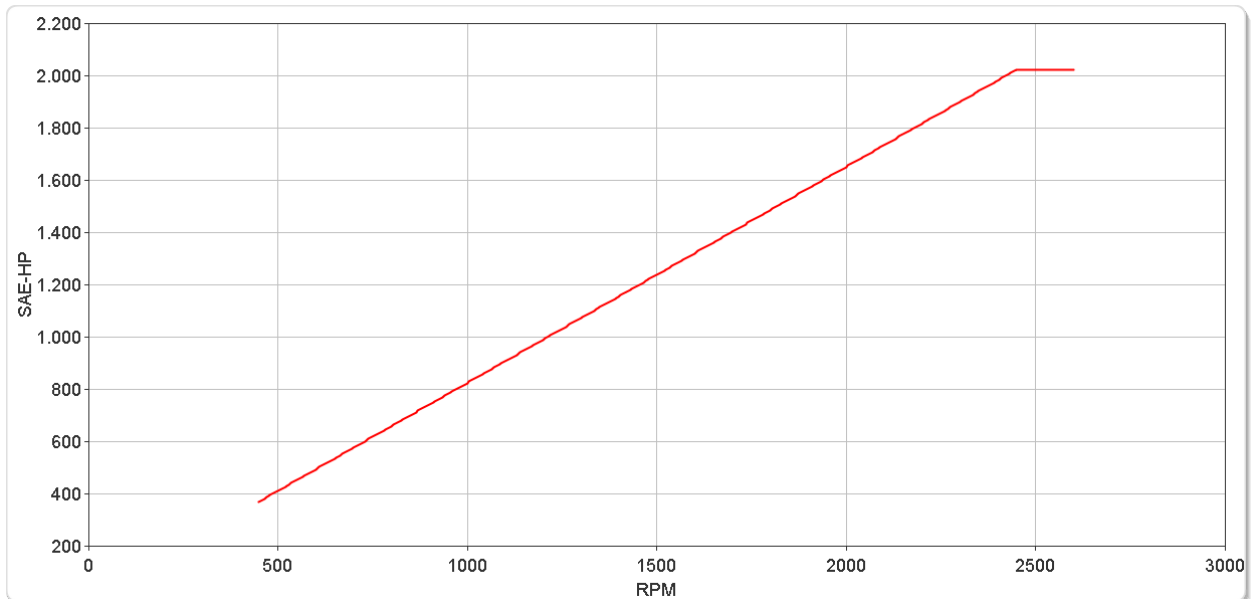
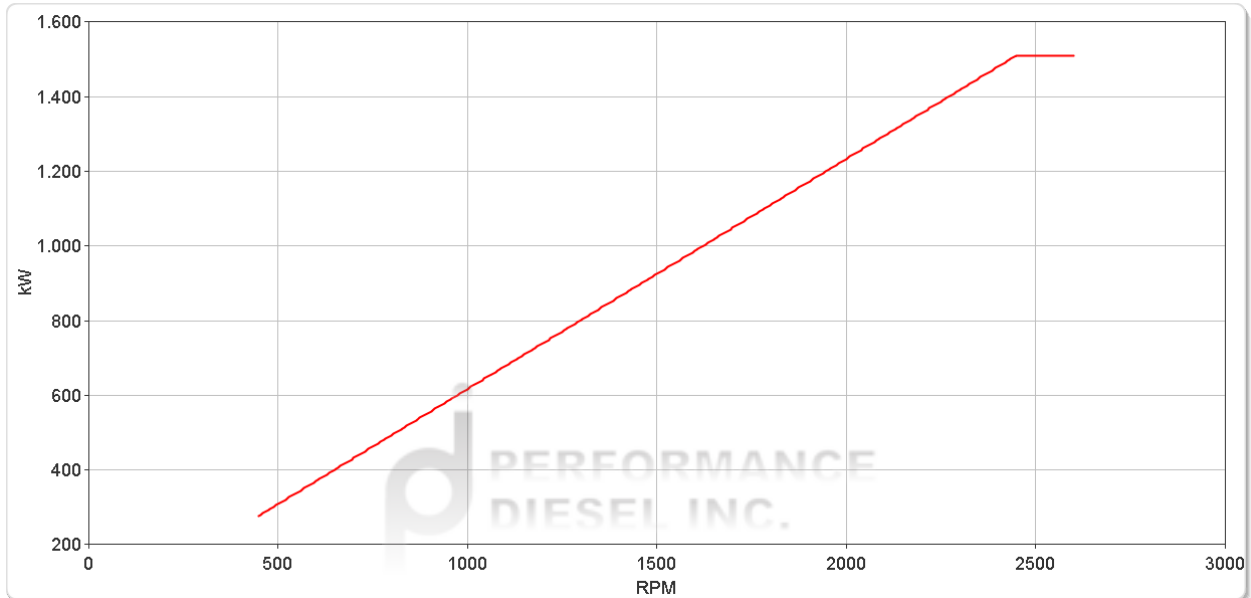

# ZF 3050 D

## Ratings

### Light Duty

	RATIOS	MAX. TORQUE		POWER/RPM		INPUT POWER CAPACITY						MAX. RPM
		Nm	ftlb	kW	hp	2100 rpm		2300 rpm		2450 rpm		
						kW	hp	kW	hp	kW	hp	
■	1.093*, 1.250*, 1.441*, 1.500, 1.563*, 1.645*, 1.700*, 1.733*, 1.800*, 1.828*, 2.037, 2.240*, 2.375*, 2.500, 2.609*, 2.773*, 2.952*	5361	3954	0.5614	0.7528	1179	1581	1291	1731	1375	1844	2600

\* Special Order Ratio.

D - transmissions only for counter engine wise rotation available (waterjet application). Reversing feature for cleaning the jet possible.

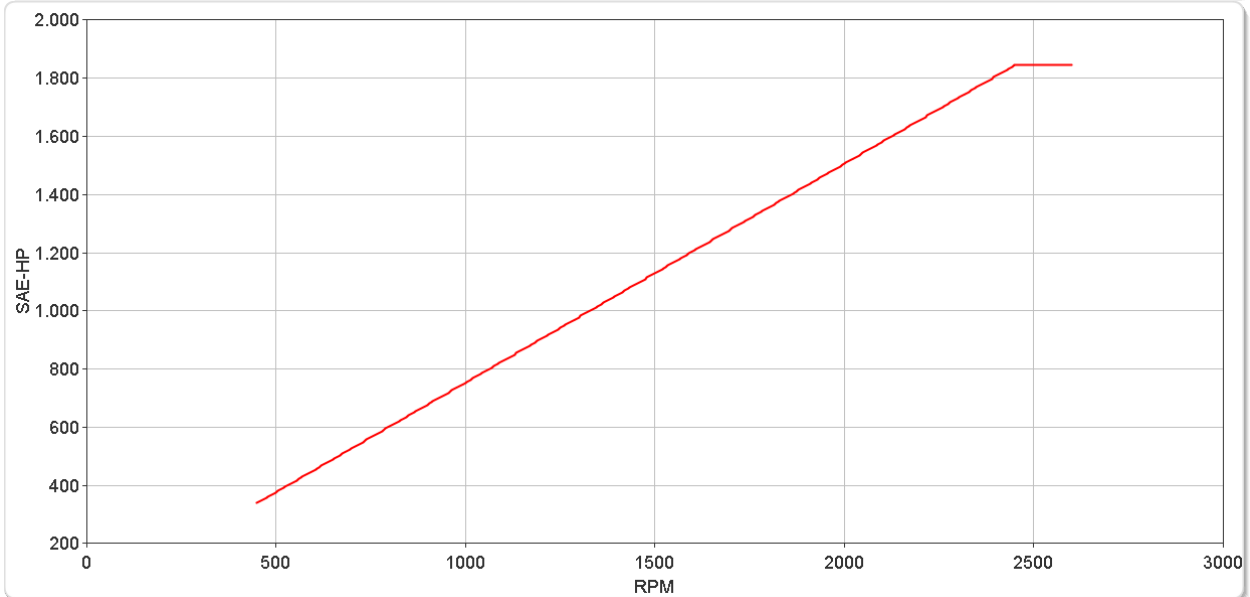
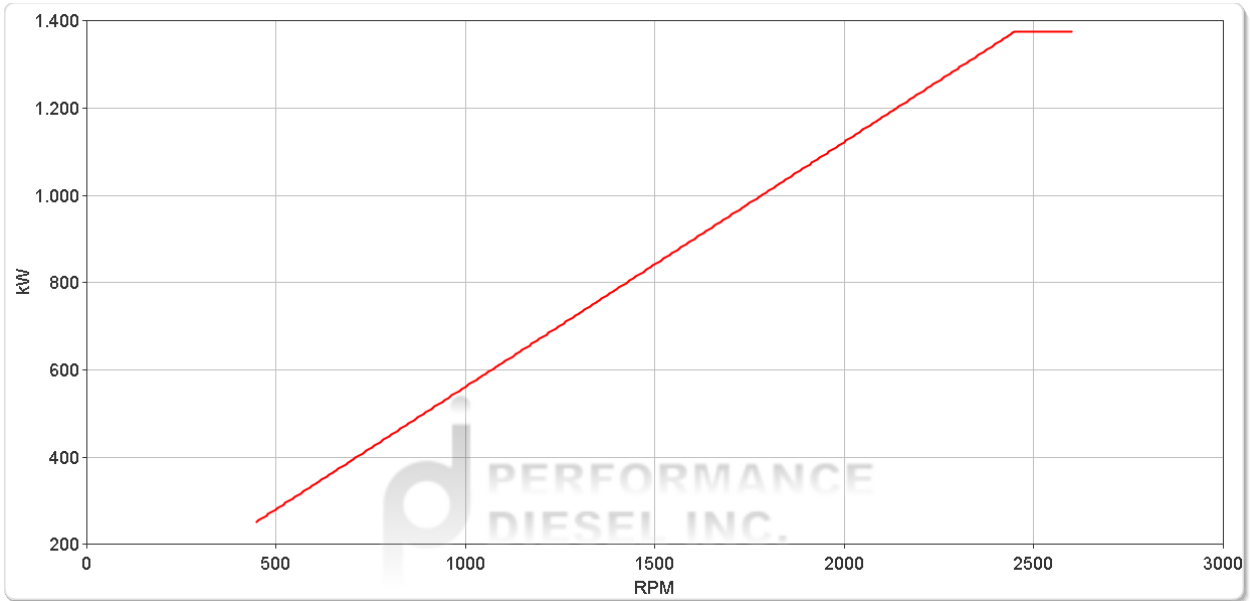

# ZF 3050 D

## Ratings

### Medium Duty

RATIOS	MAX. TORQUE		POWER/RPM		INPUT POWER CAPACITY						MAX. RPM
	Nm	ftlb	kW	hp	1800 rpm		2100 rpm		2250 rpm		
<span style="color: red;">■</span> 1.093*, 1.250*, 1.441*, 1.500, 1.563*, 1.645*, 1.700*, 1.733*, 1.800*, 1.828*, 2.037, 2.240*, 2.375*, 2.500, 2.609*, 2.773*, 2.952*	4921	3630	0.5153	0.6910	928	1244	1082	1451	1159	1555	2600

\* Special Order Ratio.

D - transmissions only for counter engine wise rotation available (waterjet application). Reversing feature for cleaning the jet possible.

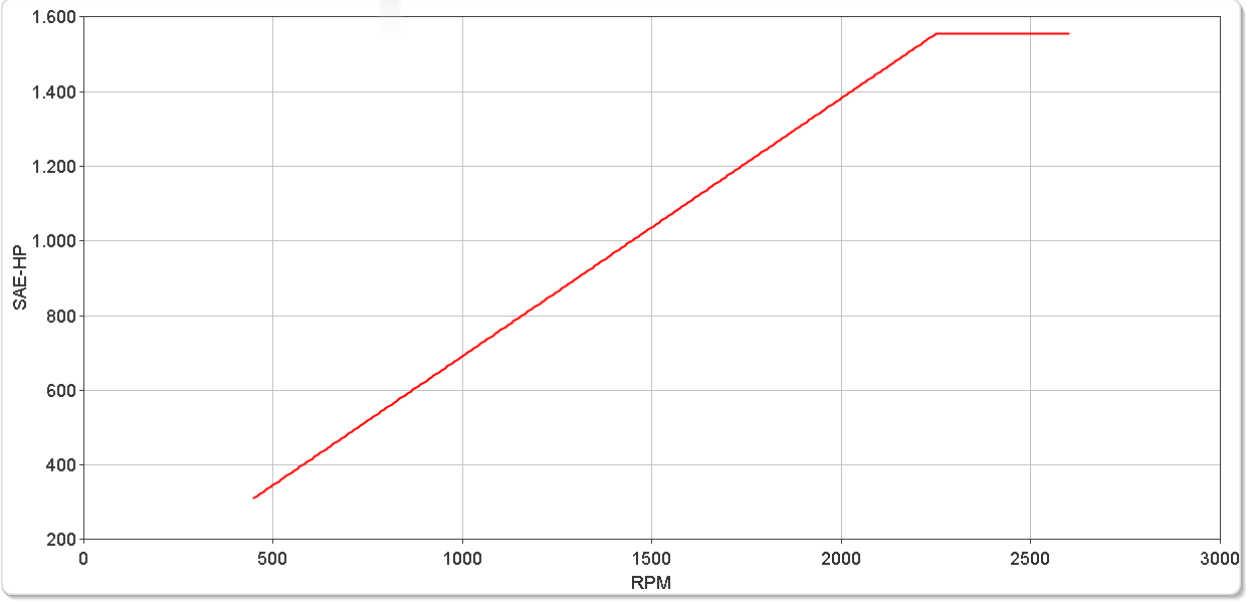
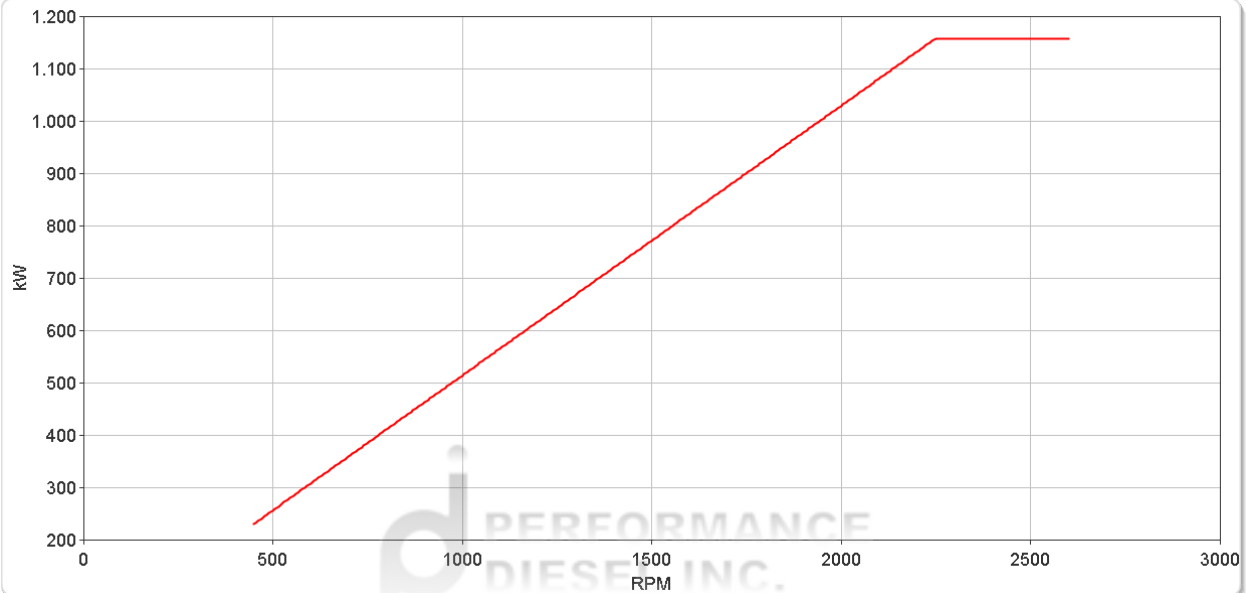

# ZF 3050 D

## Ratings

### Continuous Duty

RATIOS	MAX. TORQUE		POWER/RPM		INPUT POWER CAPACITY						MAX. RPM
	Nm	ftlb	kW	hp	1600 rpm		1800 rpm		2100 rpm		
<span style="color: red;">■</span> 1.093*, 1.250*, 1.441*, 1.500, 1.563*, 1.645*, 1.700*, 1.733*, 1.800*, 1.828*, 2.037, 2.240*, 2.375*, 2.500, 2.609*, 2.773*, 2.952*	4454	3285	0.4664	0.6254	746	1001	839	1126	979	1313	2100

\* Special Order Ratio.

D - transmissions only for counter engine wise rotation available (waterjet application). Reversing feature for cleaning the jet possible.

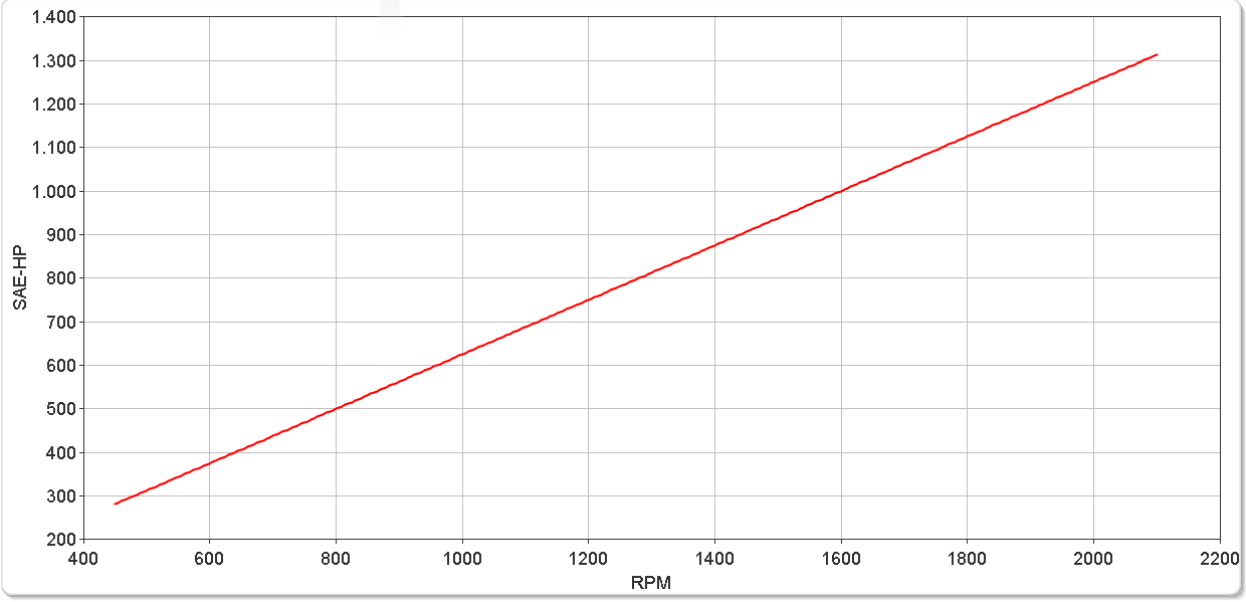
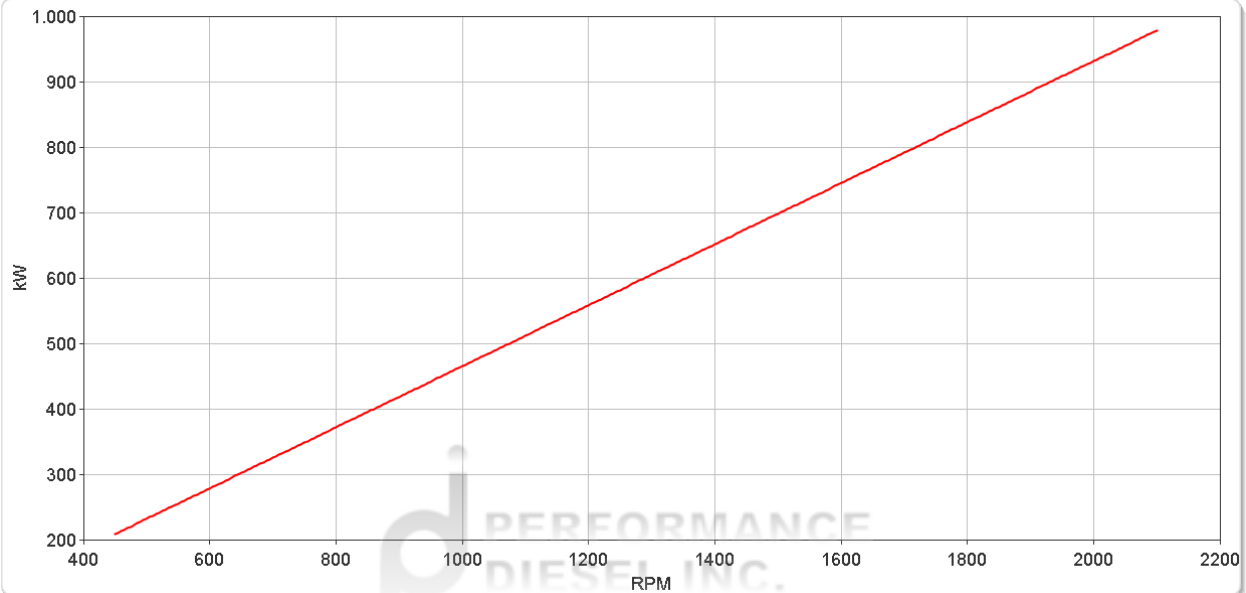

# ZF 3050 D

## Dimensions

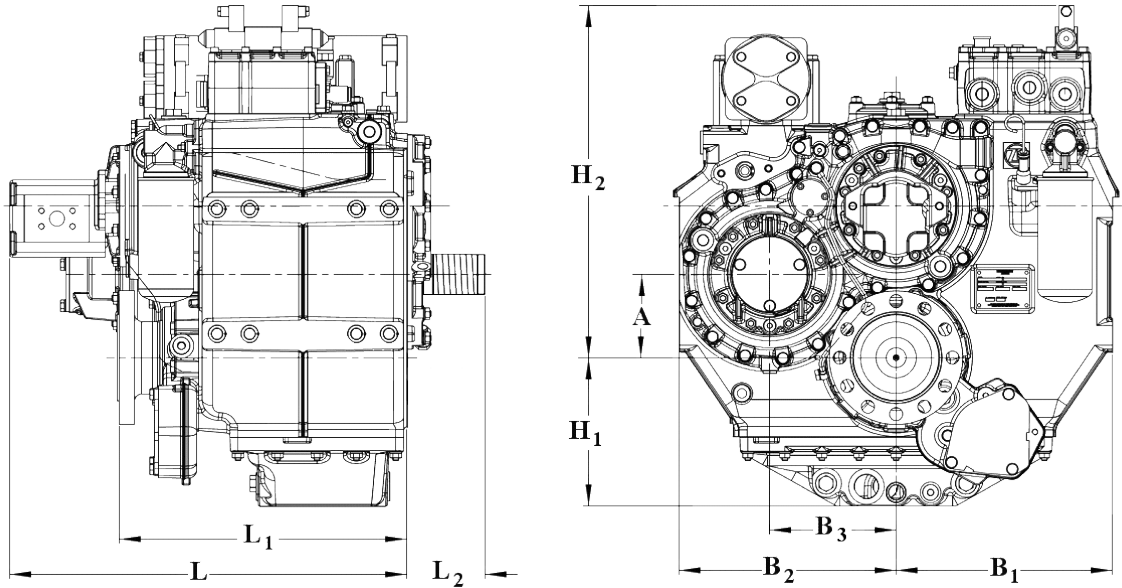

mm (inches)									
A	B <sub>1</sub>	B <sub>2</sub>	B <sub>3</sub>	B <sub>4</sub>	H <sub>1</sub>	H <sub>2</sub>	L	L <sub>1</sub>	L <sub>2</sub>
140 (5.52)	365 (14.4)	365 (14.4)	213 (8.39)	213 (8.39)	250 (9.84)	593 (23.4)	670 (26.4)	485 (19.1)	132 (5.20)
Weight kg (lb)					Oil Capacity Litre (US qt)				
482 ( 1,062)					31.0 (32.9)				

### Output Coupling Dimensions

A		B		C		D		No.	Bolt Holes Diameter (E)	
mm	in	mm	in	mm	in	mm	in		mm	in
225	8.86	190	7.48	145	5.71	25.0	0.98	12	22.2	0.87

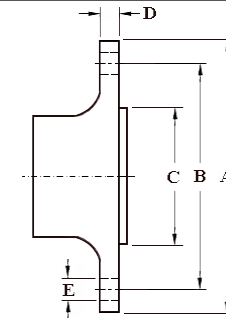

## Duty Definitions

<b>PLEASURE DUTY DEFINITION</b>	Highly intermittent operation with very large variations in engine speed and power
Average engine operating hours limit:	500 hours/year 300 hours/year for mechanical gearboxes
Typical hull forms:	Planing.
Typical applications:	Private, non-commercial, non-charter sport/leisure activities.
<b>LIGHT DUTY DEFINITION</b>	Intermittent operation with large variations in engine speed and power
Average engine operating hours limit:	2500 hours/year (for hydraulic gearboxes smaller than the ZF 650 series, 2000 hours/year).
Typical hull forms:	Planing and semi-displacement.
Typical applications:	Private and charter, sport/leisure activities, naval and police activities.
<b>MEDIUM DUTY DEFINITION</b>	Intermittent operation with some variations in engine speed and power
Average engine operating hours limit:	4000 hours/year. 3500 hours/year for gearboxes smaller than ZF 2000 series and workboat ZF W2700 series.
Typical hull forms:	Semi-displacement and displacement
Typical applications:	Charter and commercial craft (example: crew boats and fast ferries), and naval and police activities.
<b>CONTINUOUS DUTY DEFINITION</b>	Continuous operation with little or no variations in engine speed and power
Average engine operating hours limit:	Unlimited
Typical hull forms:	Displacement.
Typical applications:	Heavy duty commercial vessels, tugs, fishing boats.

## Duty Ratings

Ratings apply to marine diesel engines at the indicated speeds. At other engine speeds, the respective power capacity (kW) of the transmission can be obtained by multiplying the Power/Speed ratio by the speed.

Approximate conversion factors:

1 kW = 1.36 metric hp

1 kW = 1.34 U.S. hp (SAE)

1 U.S. hp = 1.014 metric hp

1 Nm = 0.74 lb.ft.

Ratings apply to right hand turning engines, i.e. engines having counterclockwise rotating flywheels when viewing the flywheel end of the engine.

These ratings allow full power through forward and reverse gear trains, unless otherwise stated.

Contact your nearest ZF Sales and Service office for ratings applicable to gas turbines, gasoline (petrol) engines, as well as left hand turning engines, and marine transmissions for large horsepower capacity engines.

Ratings apply to marine transmissions currently in production or in development and are subject to change without prior notice.

**NOTE: THE MAXIMUM RATED INPUT POWER MUST NOT BE EXCEEDED (SEE RESPECTIVE RATINGS IN THE TECHNICAL DATA SHEETS)**

## Safe Operating Notice

The safe operation of ZF products depends upon adherence to technical data presented in our brochures. Safe operation also depends upon proper installation, operation and routine maintenance and inspection under prevailing conditions and recommendations set forth by ZF. Damage to transmission caused by repeated or continuous emergency manoeuvres or abnormal operation is not covered under warranty. It is the responsibility of users and not ZF to provide and install guards and safety devices, which may be required by recognized safety standards of the respective country (e.g. for U.S.A. the Occupational Safety Act of 1970 and its subsequent provisions).

## Monitoring Notice

The safe operation of ZF products depends upon adherence to ZF monitoring recommendations presented in our operating manuals, etc. It is the responsibility of users and not ZF to provide and install monitoring devices and safety interlock systems as may be deemed prudent by ZF. Consult ZF for details and recommendations.

## Torsional Responsibility and Torsional Couplings

The responsibility for ensuring torsional compatibility rests with the assembler of the drive and driven equipment. ZF can accept no liability for gearbox noise caused by vibrations or for damage to the gearbox, the flexible coupling or to other parts of the drive unit caused by this kind of vibration. Contact ZF for further information and assistance. ZF recommends the use of a torsional limit stop for single engine powered boats, wherein loss of propulsion power can result in loss of control. It is the buyer's responsibility to specify this option, which can result in additional cost and a possible increase in installation length.

ZF can accept no liability for personal injury, loss of life, or damage or loss of property due to the failure of the buyer to specify a torsional limit stop. ZF selects torsional couplings on the basis of nominal input torque ratings and commonly accepted rated engine governed speeds. Consult ZF for details concerning speed limits of standard offering torsional couplings, which can be less than the transmission limit. Special torsional couplings may be required for Survey Society Ice Classification requirements.

