

ZF 45 IV

20° V-drive, direct mount marine transmission.

Description

- Reverse reduction marine transmission with hydraulically actuated multi-disc clutches .
- Vee-Drive unit suitable for ski-boat application .
- Suitable for high performance applications skiboats and waterjets. .
- Fully works tested, reliable and simple to install .
- Design, manufacture and quality control standards comply with ISO 9001 .
- Compatible with all types of engines and propulsion systems, including waterjets and surface- piercing propellers, as applicable .
- Max input torque and power can not be transmitted when shifting lever is in position «B». «B» position in used only for reverse operation during docking and low speed maneuvering .
- Only for single-engine application .

Features

- Lightweight and robust aluminum alloy casing (sea water resistant) .
- Case hardened and precisely ground gear teeth for long life and smooth running .
- Output shaft thrust bearing designed to take maximum propeller thrust astern and ahead .
- B/W connection integrated with casing .
- Smooth and reliable hydraulic shifting with control lever for attachment of push-pull cable .
- The reversible oil pump makes the gearbox suitable for use with right hand or left hand rotation engine .
- Replaceable oil filter .
- ZF 45 IV is created by the summary of ZF 45C (FORE) with a Vee-drive unit (AFT). The FORE part needs an optional oil cooler, meanwhile the AFT part has an Integrated Oil Cooler .
- Total oil content is 3 liters: TWO (2) liters in the FORE part, and only ONE (1) in the AFT part (Vee-drive unit) .

Options

- Engine-matched dual stage coupling .
- SAE 3 and SAE 4 bell housings .
- Propeller shaft flange .
- Control cable bracket for mounting of push-pull cable to the control lever .
- Electric clutch control available (12 VDC) .
- Classification by all major Classification Societies on request .
- Oil cooler for the fore part .

ZF 45 IV

Ratings

Pleasure Duty

	RATIOS		MAX. TORQUE		POWER/RPM		INPUT POWER CAPACITY				MAX. RPM		
	'A' Pos	'B' Pos	Nm	ftlb	kW	hp	2800 rpm		3300 rpm			3800 rpm	
							kW	hp	kW	hp		kW	hp
■	1.207	1.244	530	391	0.0555	0.0744	155	208	183	246	211	283	5500
■	1.462	1.507	530	391	0.0555	0.0744	155	208	183	246	211	283	5500

'A' POS = continuous running position (normally AHEAD). 'B' POS = reverse position.
 For ZF 45 C, ZF 45 IV, ZF 45-1 IV, ZF 63 C and ZF 88 C - Full power in 'A' POS only, 'B' POS for docking and low speed maneuvering.

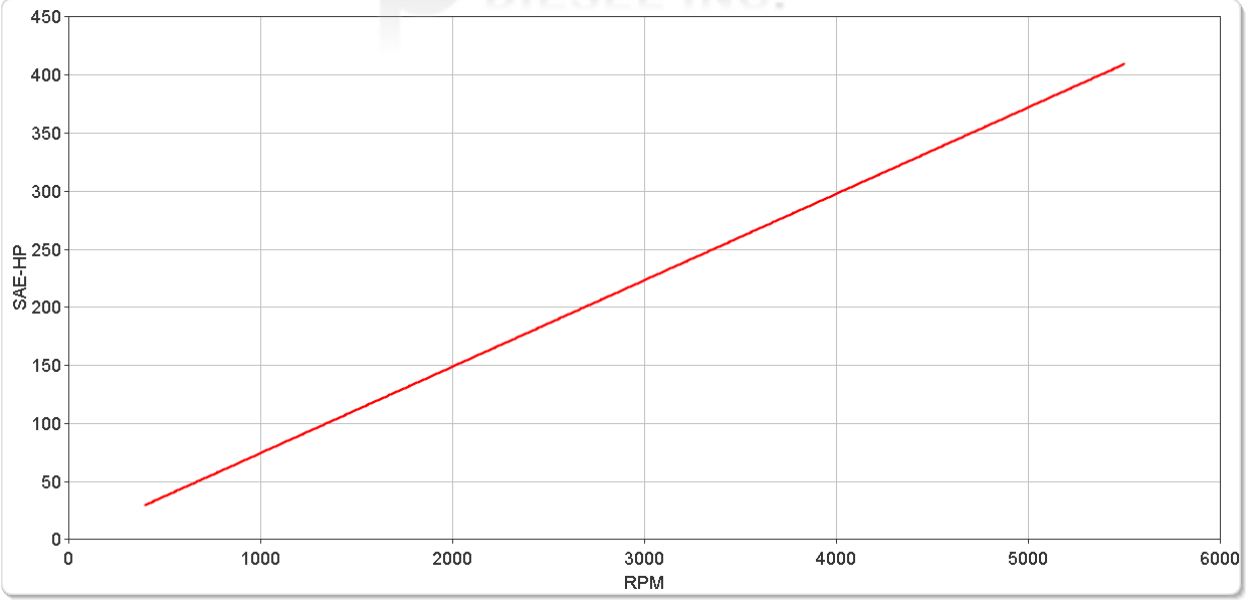
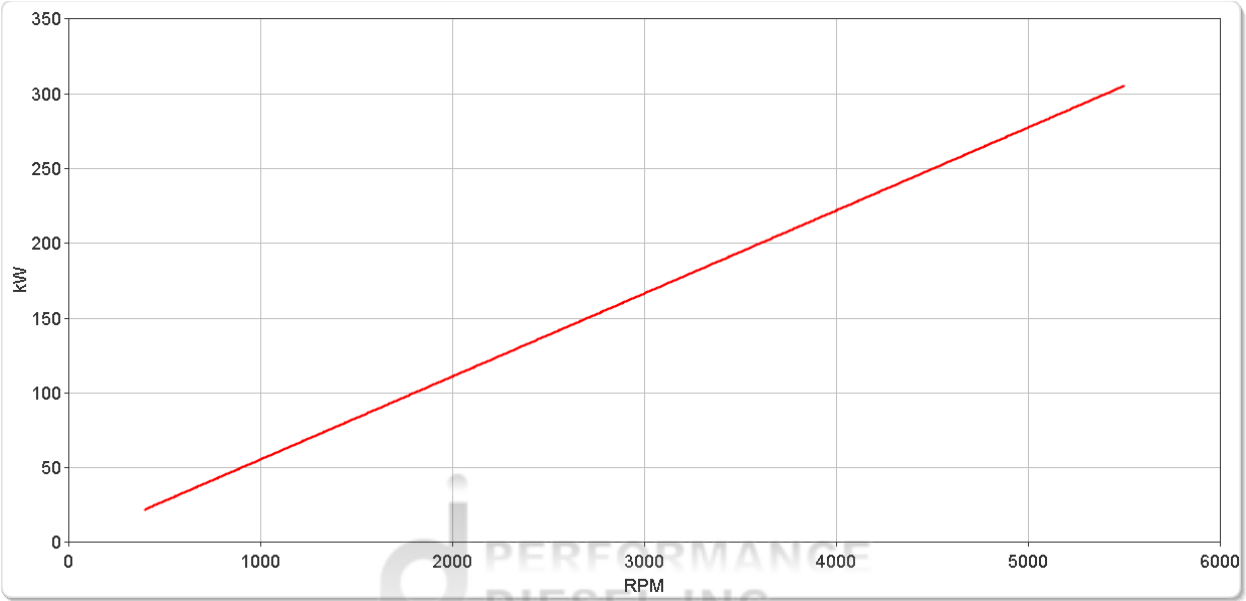

ZF 45 IV

Ratings

Pleasure Duty Gasoline

	RATIOS		MAX. TORQUE		POWER/RPM		INPUT POWER CAPACITY						MAX. RPM
	'A' Pos	'B' Pos	Nm	ftlb	kW	hp	4000 rpm		4400 rpm		4800 rpm		
							kW	hp	kW	hp	kW	hp	
■	1.207	1.244	530	391	0.0555	0.0744	222	298	244	327	266	357	5500
■	1.462	1.507	530	391	0.0555	0.0744	222	298	244	327	266	357	5500

'A' POS = continuous running position (normally AHEAD). 'B' POS = reverse position.

For ZF 45 C, ZF 45 IV, ZF 45-1 IV, ZF 63 C and ZF 88 C - Full power in 'A' POS only, 'B' POS for docking and low speed maneuvering.

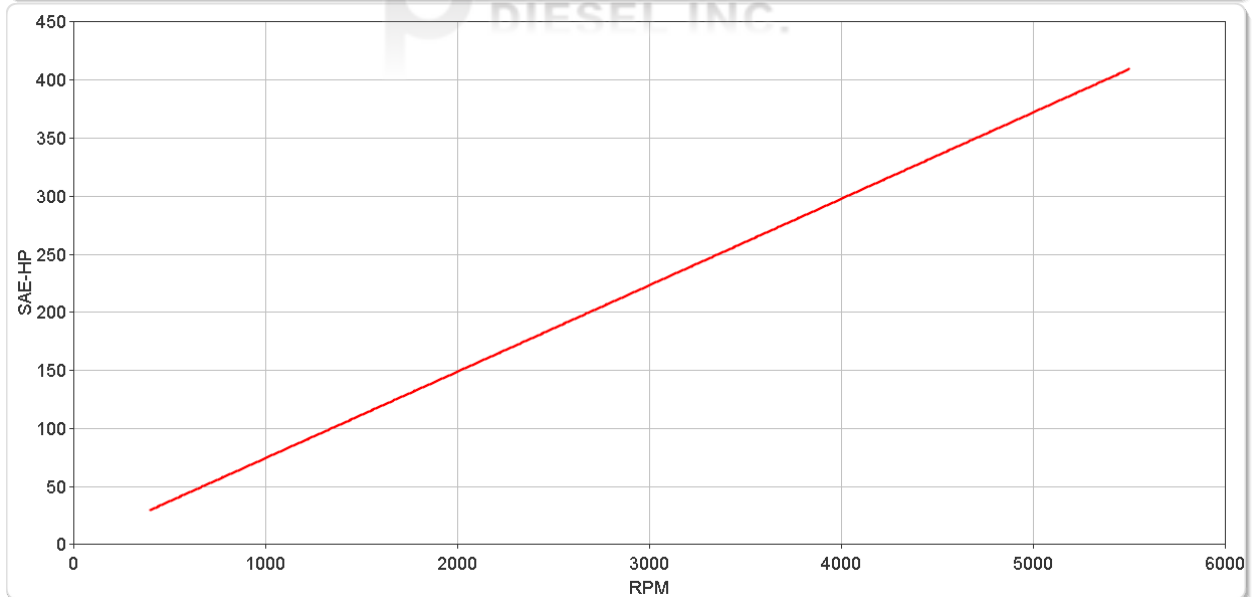
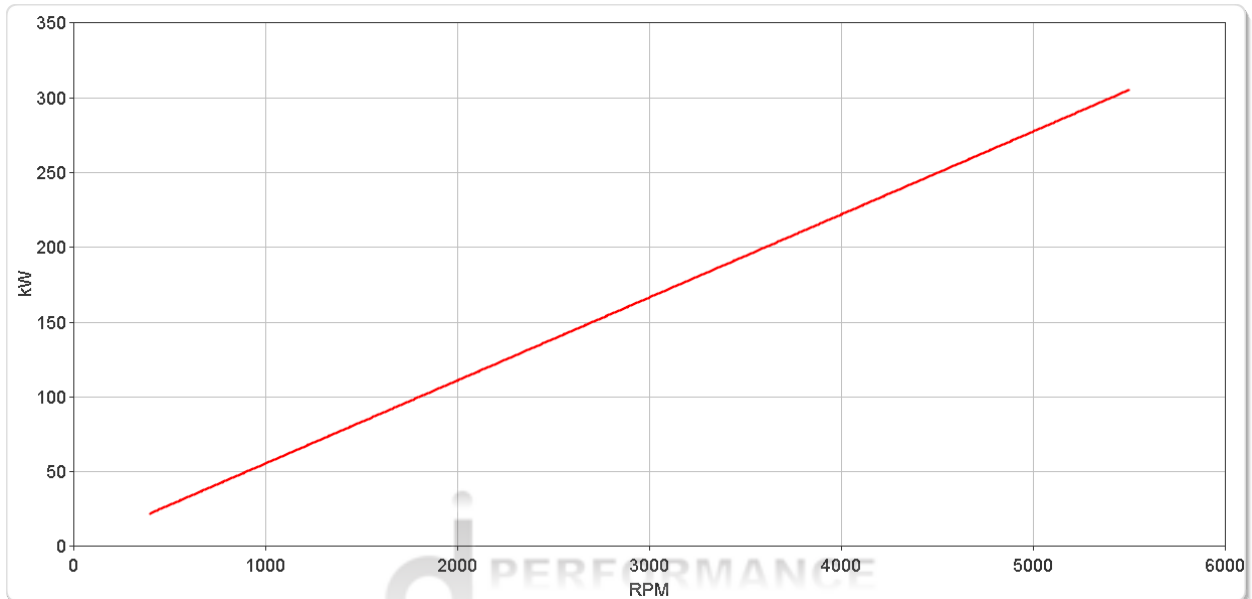

ZF 45 IV

Ratings

Light Duty

	RATIOS		MAX. TORQUE		POWER/RPM		INPUT POWER CAPACITY						MAX. RPM
	'A' Pos	'B' Pos	Nm	ftlb	kW	hp	2800 rpm		3300 rpm		3800 rpm		
							kW	hp	kW	hp	kW	hp	
■	1.207	1.244	395	291	0.0414	0.0555	116	155	136	183	157	211	5500
■	1.462	1.507	395	291	0.0414	0.0555	116	155	136	183	157	211	5500

'A' POS = continuous running position (normally AHEAD). 'B' POS = reverse position.
 For ZF 45 C, ZF 45 IV, ZF 45-1 IV, ZF 63 C and ZF 88 C - Full power in 'A' POS only, 'B' POS for docking and low speed maneuvering.

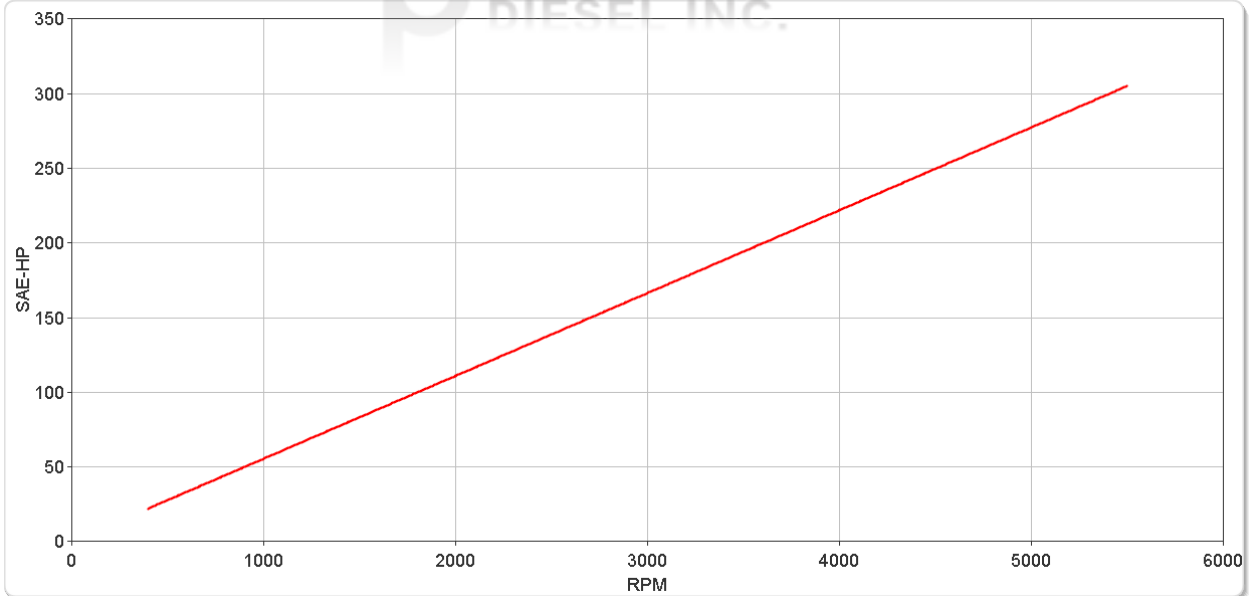
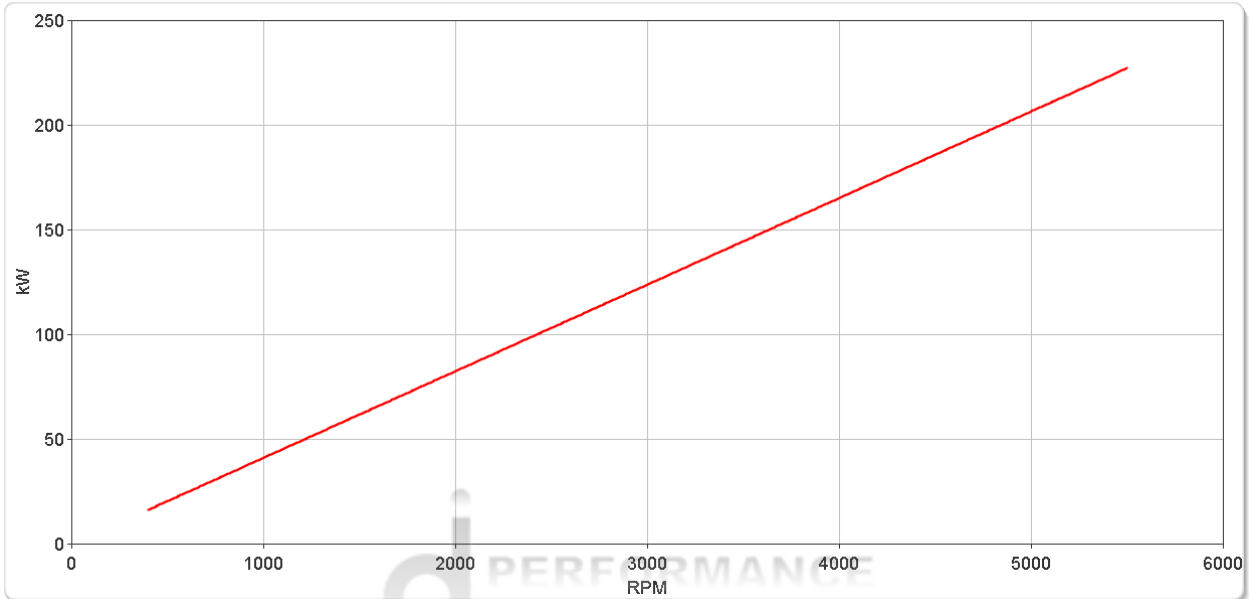

ZF 45 IV

Dimensions

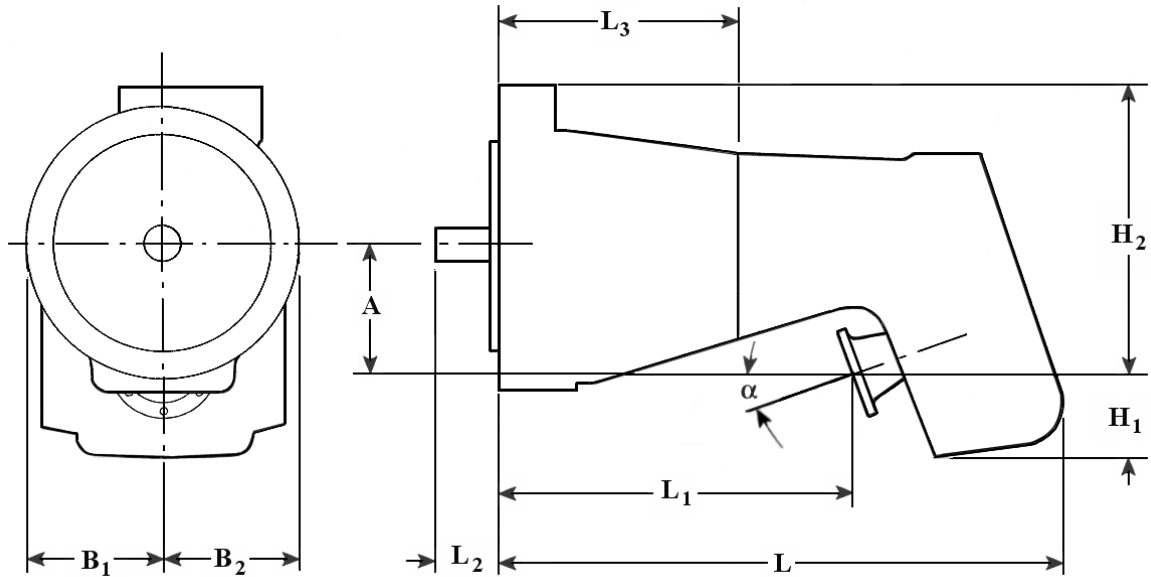

mm (inches)										
Angle	A	B ₁	B ₂	H ₁	H ₂	L	L ₁	L ₂	L ₃	Bell Hsg. B/W
20.0	126 (4.96)	131 (5.15)	136 (5.35)	83.0 (3.27)	309 (12.2)	554 (21.8)	348 (13.7)	64.5 (2.54)	219 (8.61)	
Weight kg (lb)					Oil Capacity Litre (US qt)					
47.0 (103)					3.00 (3.15)					

SAE Bell Housing Dimensions

SAE No.	A		B		C		Bolt Holes		
	mm	in	mm	in	mm	in	No.	Diameter	
	mm	in	mm	in	mm	in	No.	mm	in
3	409.58	16.125	428.63	16.875	450.85	17.75	12	10.32	13/32
4	361.95	14.25	381.0	15.0	403.23	15.875	12	10.32	13/32

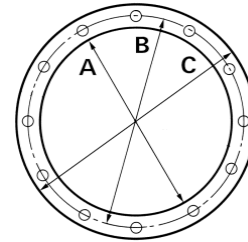

Output Coupling Dimensions

A		B		C		D		Bolt Holes		
mm	in	mm	in	mm	in	mm	in	No.	Diameter (E)	
mm	in	mm	in	mm	in	mm	in	No.	mm	in
102	4.00	82.5	3.25	63.5	2.50	10.0	0.39	4	11.5	0.45

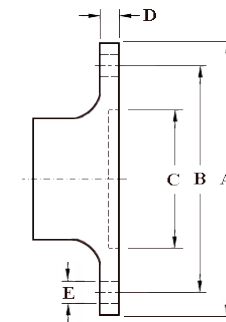

Duty Definitions

PLEASURE DUTY DEFINITION Highly intermittent operation with very large variations in engine speed and power

Average engine operating 500 hours/year
hours limit: 300 hours/year for mechanical gearboxes

Typical hull forms: Planing.

Typical applications: Private, non-commercial, non-charter sport/leisure activities.

LIGHT DUTY DEFINITION Intermittent operation with large variations in engine speed and power

Average engine operating 2500 hours/year
hours limit: (for hydraulic gearboxes smaller than the ZF 650 series, 2000 hours/year).

Typical hull forms: Planing and semi-displacement.

Typical applications: Private and charter, sport/leisure activities, naval and police activities.

Duty Ratings

Ratings apply to marine diesel engines at the indicated speeds. At other engine speeds, the respective power capacity (kW) of the transmission can be obtained by multiplying the Power/Speed ratio by the speed.

Approximate conversion factors:

1 kW = 1.36 metric hp

1 kW = 1.34 U.S. hp (SAE)

1 U.S. hp = 1.014 metric hp

1 Nm = 0.74 lb.ft.

Ratings apply to right hand turning engines, i.e. engines having counterclockwise rotating flywheels when viewing the flywheel end of the engine.

These ratings allow full power through forward and reverse gear trains, unless otherwise stated.

Contact your nearest ZF Sales and Service office for ratings applicable to gas turbines, gasoline (petrol) engines, as well as left hand turning engines, and marine transmissions for large horsepower capacity engines.

Ratings apply to marine transmissions currently in production or in development and are subject to change without prior notice.

NOTE: THE MAXIMUM RATED INPUT POWER MUST NOT BE EXCEEDED (SEE RESPECTIVE RATINGS IN THE TECHNICAL DATA SHEETS)

Safe Operating Notice

The safe operation of ZF products depends upon adherence to technical data presented in our brochures. Safe operation also depends upon proper installation, operation and routine maintenance and inspection under prevailing conditions and recommendations set forth by ZF. Damage to transmission caused by repeated or continuous emergency manoeuvres or abnormal operation is not covered under warranty. It is the responsibility of users and not ZF to provide and install guards and safety devices, which may be required by recognized safety standards of the respective country (e.g. for U.S.A. the Occupational Safety Act of 1970 and its subsequent provisions).

Monitoring Notice

The safe operation of ZF products depends upon adherence to ZF monitoring recommendations presented in our operating manuals, etc. It is the responsibility of users and not ZF to provide and install monitoring devices and safety interlock systems as may be deemed prudent by ZF. Consult ZF for details and recommendations.

Torsional Responsibility and Torsional Couplings

The responsibility for ensuring torsional compatibility rests with the assembler of the drive and driven equipment. ZF can accept no liability for gearbox noise caused by vibrations or for damage to the gearbox, the flexible coupling or to other parts of the drive unit caused by this kind of vibration.

Contact ZF for further information and assistance. ZF recommends the use of a torsional limit stop for single engine powered boats, wherein loss of propulsion power can result in loss of control. It is the buyer's responsibility to specify this option, which can result in additional cost and a possible increase in installation length.

ZF can accept no liability for personal injury, loss of life, or damage or loss of property due to the failure of the buyer to specify a torsional limit stop.

ZF selects torsional couplings on the basis of nominal input torque ratings and commonly accepted rated engine governed speeds. Consult ZF for details concerning speed limits of standard offering torsional couplings, which can be less than the transmission limit. Special torsional couplings may be required for Survey Society Ice Classification requirements.

