

ZF 53000 NR2H

Horizontal offset, remote mount marine transmission.

Description

- Design, manufacture and quality control standards comply with ISO 9001 and AQAP .
- Marine transmission with reduction drive gearing and hydraulically actuated multi-disc clutch for engagement .
- Low weight design for heavy duty fast ferry applications. Also suitable for other weight sensitive craft, e.g. high speed motor yachts. .
- Compatible with all types of engines and water jet propulsion. .
- Output shaft rotating in the opposite direction to that of the input shaft.
- Easy installation and fully works tested for guaranteed reliability .

Features

- Case hardened and precisely ground gear teeth for long life and smooth running .
- Compact, space-saving design, complete with integral oil cooler, pump and full-flow filter .
- Modular component design for fast and easy service and repair. .
- Lightweight cast aluminum alloy housing resistant to sea water corrosion. .
- Smooth and reliable clutch operation with hydraulically controlled clutch engagement and electrical actuation .
- One power take off (PTO) drive with SAE connection, permanently connected and driven from the input shaft. .
- Trailing pump to guarantee adequate transmission lubrication when the output shaft is rotated with the input shaft stationary. .
- HW version: special "AntiFlex" mounting arrangement to prevent housing and component stress as a result of hull distortion and temperature changes. .

Options

- Monitoring devices fitted and connected to a terminal box as required .
- Classification certification from all major Classification Societies available on request. .
- Trailing pump to guarantee adequate transmission lubrication when the output shaft is rotated with the input shaft stationary .
- Additional power take off (PTO) drives with SAE connections, permanently connected and driven from the input shaft .

ZF 53000 NR2H

Ratings

Light Duty

RATIOS	MAX. TORQUE		POWER/RPM		INPUT POWER CAPACITY						MAX. RPM
	Nm	ftlb	kW	hp	750 rpm		1000 rpm		1300 rpm		
■ 1.487, 1.694, 1.771, 1.853, 1.912, 2.129, 2.464	58000	42779	6.0733	8.1444	4555	6108	6073	8144	7895	10588	1350

* Special Order Ratio.

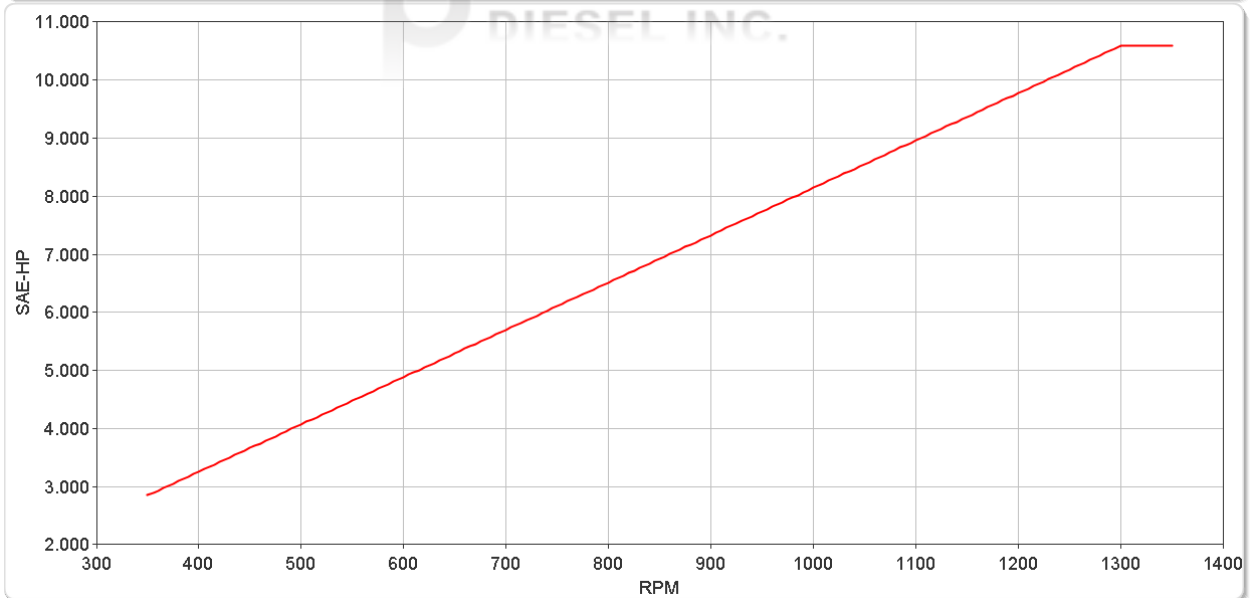
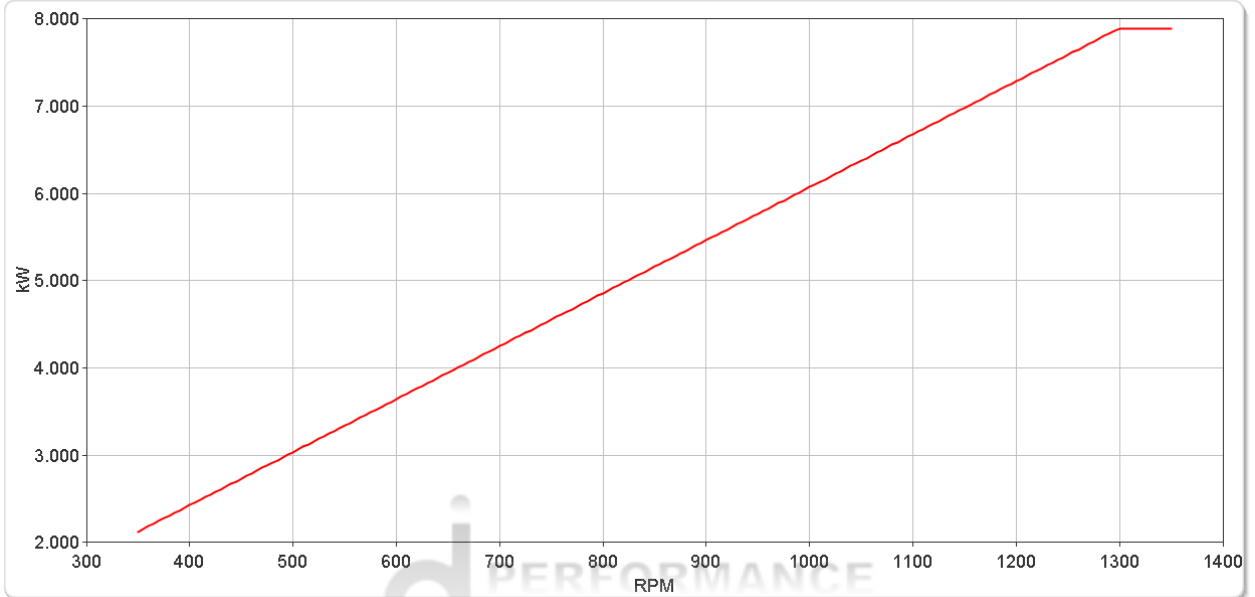

ZF 53000 NR2H

Ratings

Medium Duty

RATIOS	MAX. TORQUE		POWER/RPM		INPUT POWER CAPACITY						MAX. RPM
	Nm	ftlb	kW	hp	750 rpm		1000 rpm		1200 rpm		
■ 1.487, 1.694, 1.771, 1.853, 1.912, 2.129, 2.464	53000	39091	5.5497	7.4423	4162	5582	5550	7442	6660	8931	1350

* Special Order Ratio.

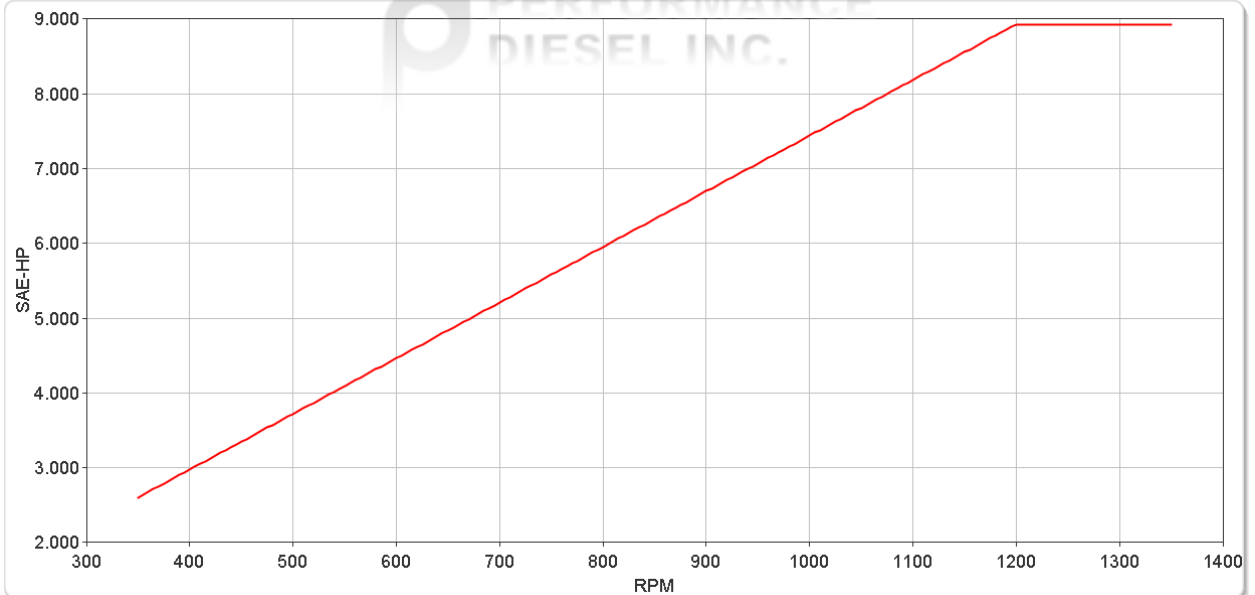
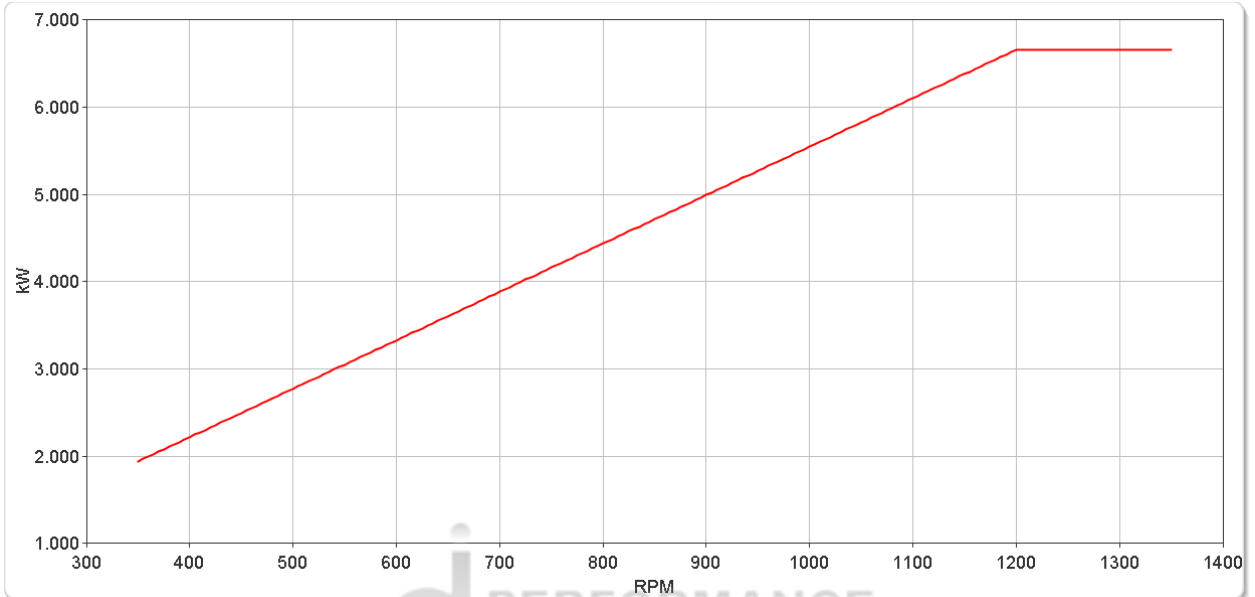

ZF 53000 NR2H

Ratings

Continuous Duty

RATIOS	MAX. TORQUE		POWER/RPM		INPUT POWER CAPACITY						MAX. RPM
	Nm	ftlb	kW	hp	750 rpm		900 rpm		1000 rpm		
■ 1.487, 1.694, 1.771, 1.853, 1.912, 2.129, 2.464	53000	39091	5.5497	7.4423	4162	5582	4995	6698	5550	7442	1350

* Special Order Ratio.

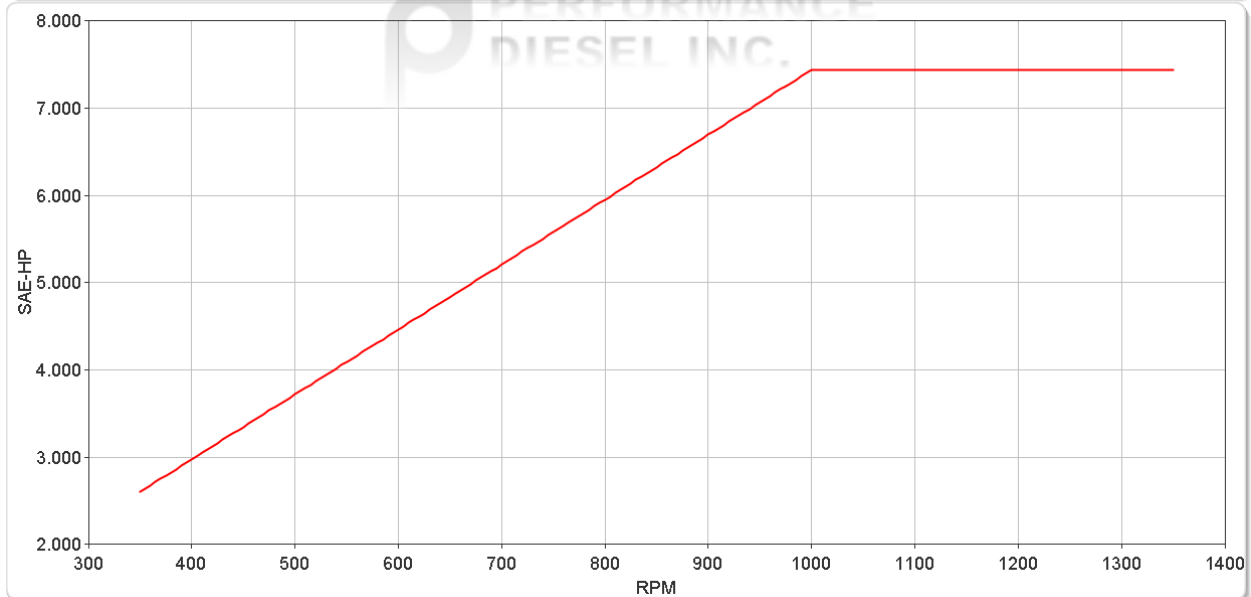
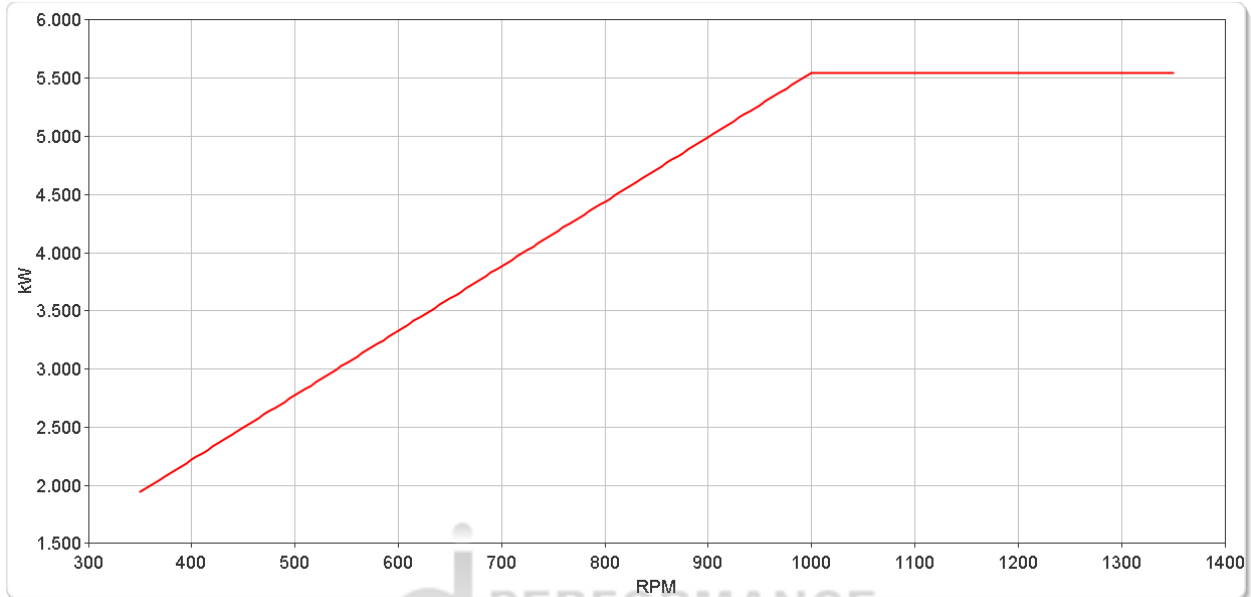

ZF 53000 NR2H

Dimensions

"L" Version Shown

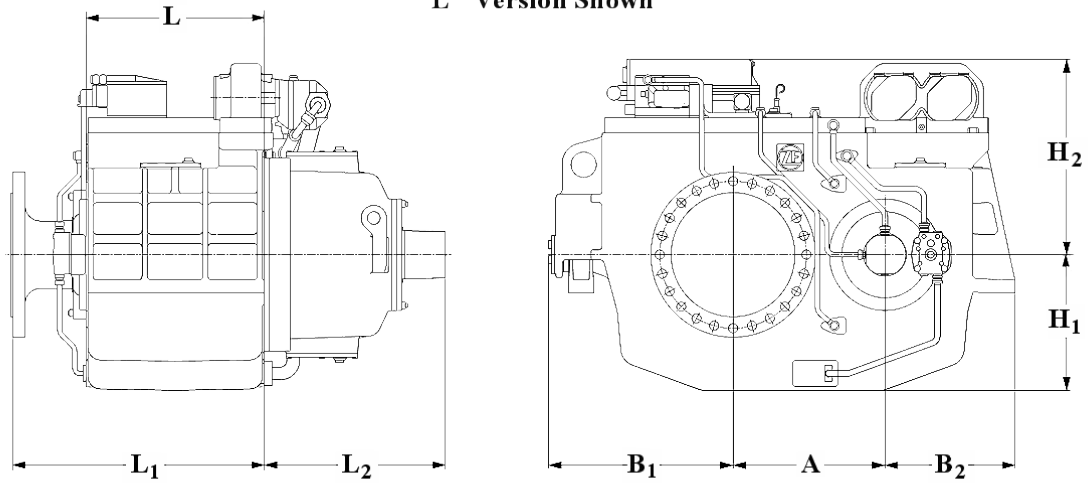

mm (inches)							
A	B ₁	B ₂	H ₁	H ₂	L	L ₁	L ₂
600 (23.6)	730 (28.7)	515 (20.3)	535 (21.1)	770 (30.3)	705 (27.8)	995 (39.2)	716 (28.2)
Weight kg (lb)				Oil Capacity Litre (US qt)			
3,750 (8,250)				200 (212)			

Output Coupling Dimensions

A		B		C		D		Bolt Holes	
mm	in	mm	in	mm	in	mm	in	No.	Diameter (E)
650	25.6	580	22.8	500	19.7	50.0	1.97	24	36.4 / 1.43

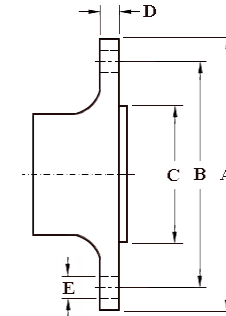

Duty Definitions

LIGHT DUTY DEFINITION	Intermittent operation with large variations in engine speed and power
Average engine operating hours limit:	2500 hours/year (for hydraulic gearboxes smaller than the ZF 650 series, 2000 hours/year).
Typical hull forms:	Planing and semi-displacement.
Typical applications:	Private and charter, sport/leisure activities, naval and police activities.
MEDIUM DUTY DEFINITION	Intermittent operation with some variations in engine speed and power
Average engine operating hours limit:	4000 hours/year. 3500 hours/year for gearboxes smaller than ZF 2000 series and workboat ZF W2700 series.
Typical hull forms:	Semi-displacement and displacement
Typical applications:	Charter and commercial craft (example: crew boats and fast ferries), and naval and police activities.
CONTINUOUS DUTY DEFINITION	Continuous operation with little or no variations in engine speed and power
Average engine operating hours limit:	Unlimited
Typical hull forms:	Displacement.
Typical applications:	Heavy duty commercial vessels, tugs, fishing boats.

Duty Ratings

Ratings apply to marine diesel engines at the indicated speeds. At other engine speeds, the respective power capacity (kW) of the transmission can be obtained by multiplying the Power/Speed ratio by the speed.

Approximate conversion factors:

1 kW = 1.36 metric hp

1 kW = 1.34 U.S. hp (SAE)

1 U.S. hp = 1.014 metric hp

1 Nm = 0.74 lb.ft.

Ratings apply to right hand turning engines, i.e. engines having counterclockwise rotating flywheels when viewing the flywheel end of the engine.

These ratings allow full power through forward and reverse gear trains, unless otherwise stated.

Contact your nearest ZF Sales and Service office for ratings applicable to gas turbines, gasoline (petrol) engines, as well as left hand turning engines, and marine transmissions for large horsepower capacity engines.

Ratings apply to marine transmissions currently in production or in development and are subject to change without prior notice.

NOTE: THE MAXIMUM RATED INPUT POWER MUST NOT BE EXCEEDED (SEE RESPECTIVE RATINGS IN THE TECHNICAL DATA SHEETS)

Safe Operating Notice

The safe operation of ZF products depends upon adherence to technical data presented in our brochures. Safe operation also depends upon proper installation, operation and routine maintenance and inspection under prevailing conditions and recommendations set forth by ZF. Damage to transmission caused by repeated or continuous emergency manoeuvres or abnormal operation is not covered under warranty. It is the responsibility of users and not ZF to provide and install guards and safety devices, which may be required by recognized safety standards of the respective country (e.g. for U.S.A. the Occupational Safety Act of 1970 and its subsequent provisions).

Monitoring Notice

The safe operation of ZF products depends upon adherence to ZF monitoring recommendations presented in our operating manuals, etc. It is the responsibility of users and not ZF to provide and install monitoring devices and safety interlock systems as may be deemed prudent by ZF. Consult ZF for details and recommendations.

Torsional Responsibility and Torsional Couplings

The responsibility for ensuring torsional compatibility rests with the assembler of the drive and driven equipment. ZF can accept no liability for gearbox noise caused by vibrations or for damage to the gearbox, the flexible coupling or to other parts of the drive unit caused by this kind of vibration. Contact ZF for further information and assistance. ZF recommends the use of a torsional limit stop for single engine powered boats, wherein loss of propulsion power can result in loss of control. It is the buyer's responsibility to specify this option, which can result in additional cost and a possible increase in installation length.

ZF can accept no liability for personal injury, loss of life, or damage or loss of property due to the failure of the buyer to specify a torsional limit stop. ZF selects torsional couplings on the basis of nominal input torque ratings and commonly accepted rated engine governed speeds. Consult ZF for details concerning speed limits of standard offering torsional couplings, which can be less than the transmission limit. Special torsional couplings may be required for Survey Society Ice Classification requirements.