



## ZF 5360

Vertical offset, remote mount marine transmission.

### Description

- 3 shaft, reverse reduction transmission with hydraulic clutch mounted on the input shaft and another one mounted on the reverse shaft. Input drive on opposite side to output drive.
- Non-reversing NR version also available .
- Fully works tested, reliable and simple to install .
- Suitable for high performance applications in all types of fast craft, luxury motoryachts, patrol vessels, crew-boats etc .
- Compatible with all types of engines.
- Compact, space-saving design, complete with oil cooler, pump and full flow filter.
- Design, manufacture and quality control standards comply with ISO 9001 .

### Features

- Lightweight cast aluminum alloy housing resistant to sea water corrosion. .
- Case hardened and precisely ground gear teeth for long life and smooth running .
- Output shaft thrust bearing designed to take maximum propeller thrust astern and ahead .
- Smooth and reliable hydraulic shifting with electric actuation .
- Emergency "get home" capability .
- Suitable for twin engine installation (same ratio and torque capacity engine-wise or counter-engine-wise) .
- Airborne and structure borne noise in accordance to ISO 8579 .

### Options

- SAE 0 or SAE .00 bell housings .
- Engine-matched torsional coupling .
- Mounting brackets .
- Propeller shaft flange and coupling bolt sets .
- Input flange .
- Mechanical actuation with lever for attachment of push-pull cable .
- Monitoring kit .
- Trailing pump .
- Classification by all major Classification Societies on request .
- Trolling valve(electrical) .
- "AUTOTROLL" .
- Live PTO's: Input shaft driven, TOP PTO .
- Disconnectable power take ins (PTI) .

# ZF 5360

## Ratings

### Pleasure Duty

	RATIOS	MAX. TORQUE		POWER/RPM		INPUT POWER CAPACITY						MAX. RPM
		Nm	ftlb	kW	hp	2100 rpm		2300 rpm		2450 rpm		
						kW	hp	kW	hp	kW	hp	
■	3.471*, 4.033, 4.464, 5.040	9600	7081	1.0052	1.3480	2111	2831	2312	3100	2463	3303	2600
■	5.500	9464	6980	0.9910	1.3289	2081	2791	2279	3057	2428	3256	2600

\* Special Order Ratio.

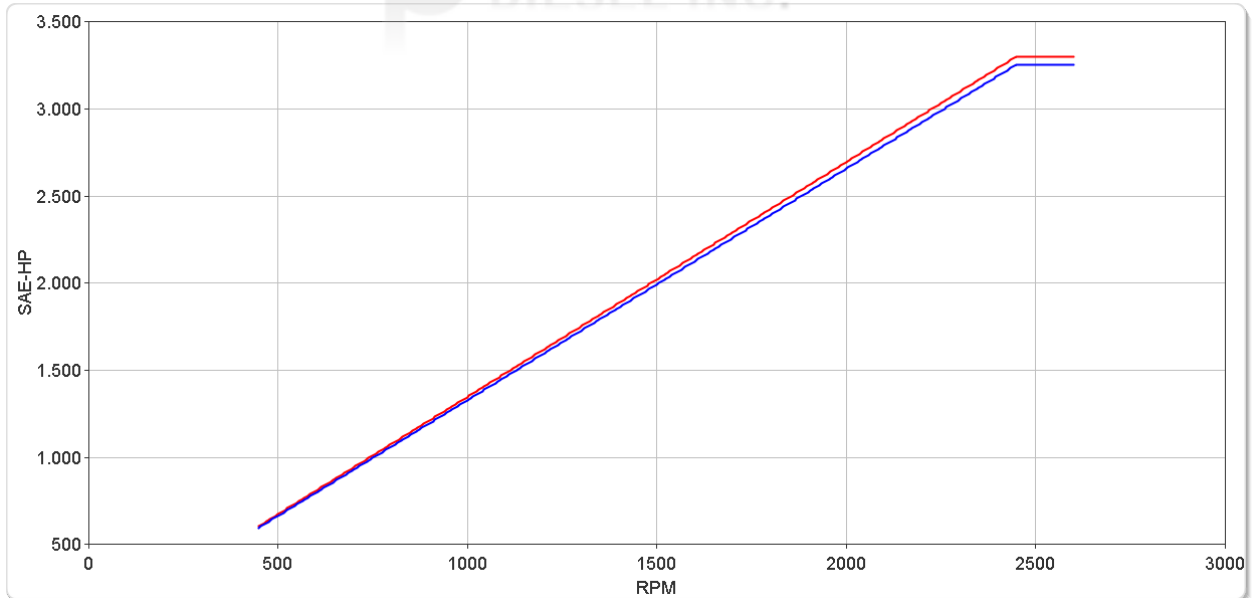
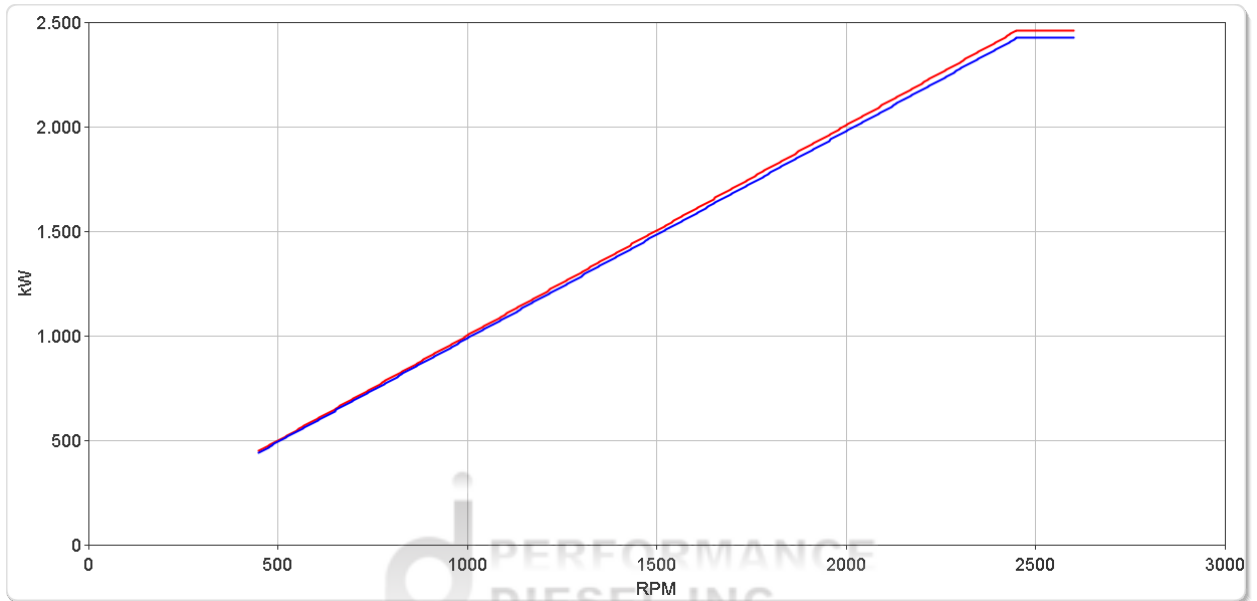

# ZF 5360

## Ratings

### Light Duty

	RATIOS	MAX. TORQUE		POWER/RPM		INPUT POWER CAPACITY						MAX. RPM
		Nm	ftlb	kW	hp	1800 rpm		2100 rpm		2300 rpm		
						kW	hp	kW	hp	kW	hp	
■	3.471*, 4.033, 4.464	9300	6859	0.9738	1.3059	1753	2351	2045	2742	2240	3004	2600
■	5.040	9010	6645	0.9435	1.2652	1698	2277	1981	2657	2170	2910	2600
■	5.500	8325	6140	0.8717	1.1690	1569	2104	1831	2455	2005	2689	2600

\* Special Order Ratio.

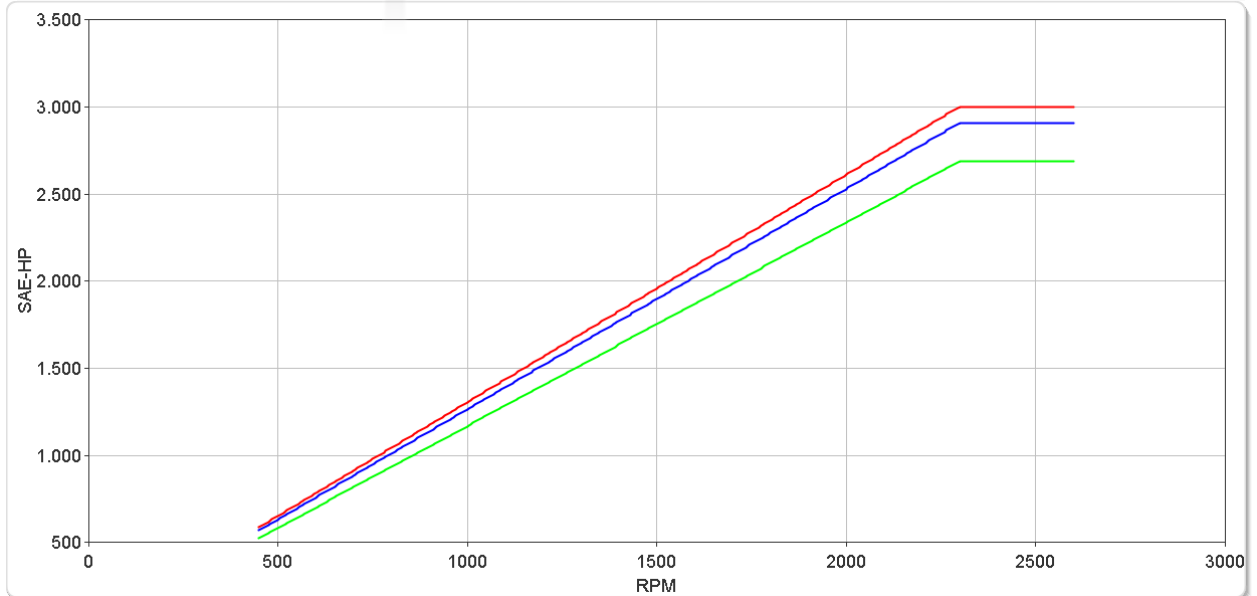
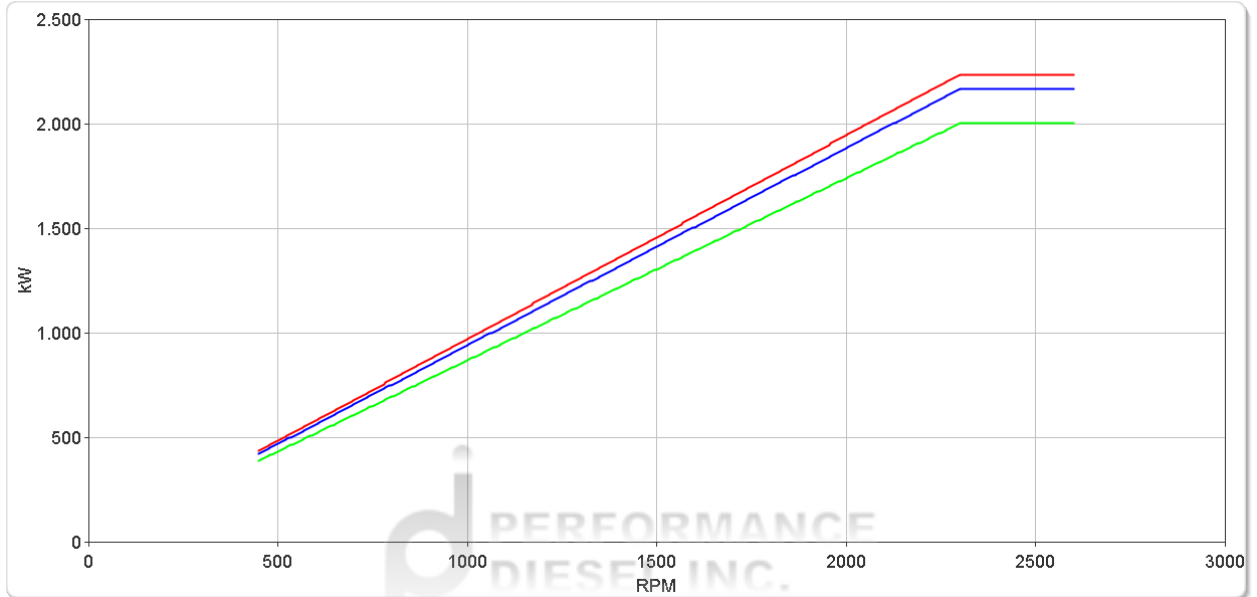

# ZF 5360

## Dimensions

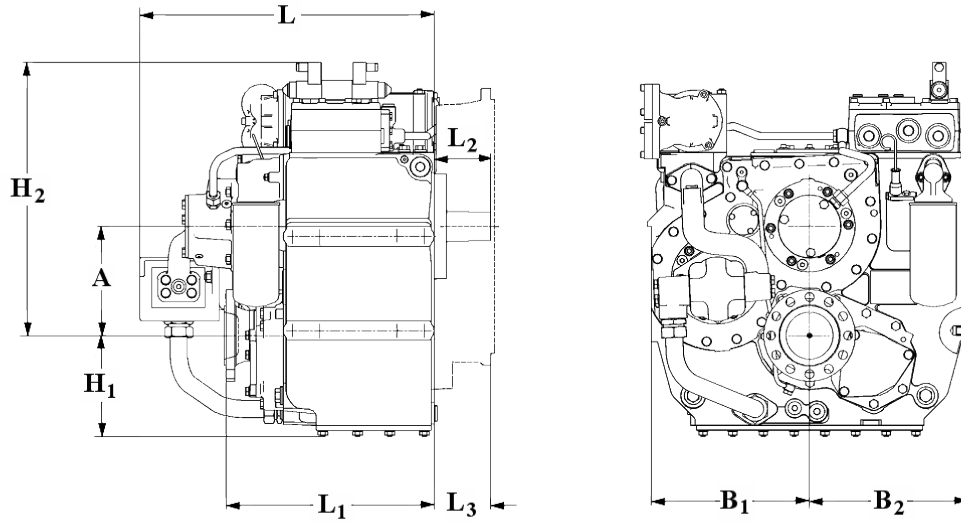

mm (inches)									
A	B <sub>1</sub>	B <sub>2</sub>	H <sub>1</sub>	H <sub>2</sub>	L	L <sub>1</sub>	L <sub>2</sub>	L <sub>3</sub>	Bell Hsg.
460 (18.1)	465 (18.3)	465 (18.3)	415 (16.3)	855 (33.6)	776 (31.1)	570 (22.3)	149 (5.90)	180 (7.10)	
Weight kg (lb)					Oil Capacity Litre (US qt)				
950 ( 2,090)					60.0 (54.0)				

### SAE Bell Housing Dimensions

SAE No.	A		B		C		No.	Bolt Holes Diameter	
	mm	in	mm	in	mm	in		mm	in
0	647.7	25.5	679.45	26.75	711.2	28.0	16	13.49	17/32

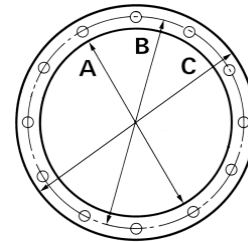

### Output Coupling Dimensions

A		B		C		D		No.	Bolt Holes Diameter (E)	
mm	in	mm	in	mm	in	mm	in		mm	in
350	13.8	310	12.2	220	8.66	35.0	1.38	18	24.2	0.95

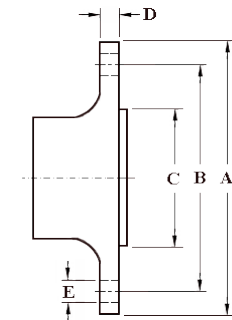

## Duty Definitions

**PLEASURE DUTY DEFINITION** Highly intermittent operation with very large variations in engine speed and power

Average engine operating 500 hours/year  
hours limit: 300 hours/year for mechanical gearboxes

Typical hull forms: Planing.

Typical applications: Private, non-commercial, non-charter sport/leisure activities.

**LIGHT DUTY DEFINITION** Intermittent operation with large variations in engine speed and power

Average engine operating 2500 hours/year  
hours limit: (for hydraulic gearboxes smaller than the ZF 650 series, 2000 hours/year).

Typical hull forms: Planing and semi-displacement.

Typical applications: Private and charter, sport/leisure activities, naval and police activities.

## Duty Ratings

Ratings apply to marine diesel engines at the indicated speeds. At other engine speeds, the respective power capacity (kW) of the transmission can be obtained by multiplying the Power/Speed ratio by the speed.

Approximate conversion factors:

1 kW = 1.36 metric hp

1 kW = 1.34 U.S. hp (SAE)

1 U.S. hp = 1.014 metric hp

1 Nm = 0.74 lb.ft.

Ratings apply to right hand turning engines, i.e. engines having counterclockwise rotating flywheels when viewing the flywheel end of the engine.

These ratings allow full power through forward and reverse gear trains, unless otherwise stated.

Contact your nearest ZF Sales and Service office for ratings applicable to gas turbines, gasoline (petrol) engines, as well as left hand turning engines, and marine transmissions for large horsepower capacity engines.

Ratings apply to marine transmissions currently in production or in development and are subject to change without prior notice.

**NOTE:** THE MAXIMUM RATED INPUT POWER MUST NOT BE EXCEEDED (SEE RESPECTIVE RATINGS IN THE TECHNICAL DATA SHEETS)

## Safe Operating Notice

The safe operation of ZF products depends upon adherence to technical data presented in our brochures. Safe operation also depends upon proper installation, operation and routine maintenance and inspection under prevailing conditions and recommendations set forth by ZF. Damage to transmission caused by repeated or continuous emergency manoeuvres or abnormal operation is not covered under warranty. It is the responsibility of users and not ZF to provide and install guards and safety devices, which may be required by recognized safety standards of the respective country (e.g. for U.S.A. the Occupational Safety Act of 1970 and its subsequent provisions).

## Monitoring Notice

The safe operation of ZF products depends upon adherence to ZF monitoring recommendations presented in our operating manuals, etc. It is the responsibility of users and not ZF to provide and install monitoring devices and safety interlock systems as may be deemed prudent by ZF. Consult ZF for details and recommendations.

## Torsional Responsibility and Torsional Couplings

The responsibility for ensuring torsional compatibility rests with the assembler of the drive and driven equipment. ZF can accept no liability for gearbox noise caused by vibrations or for damage to the gearbox, the flexible coupling or to other parts of the drive unit caused by this kind of vibration.

Contact ZF for further information and assistance. ZF recommends the use of a torsional limit stop for single engine powered boats, wherein loss of propulsion power can result in loss of control. It is the buyer's responsibility to specify this option, which can result in additional cost and a possible increase in installation length.

ZF can accept no liability for personal injury, loss of life, or damage or loss of property due to the failure of the buyer to specify a torsional limit stop.

ZF selects torsional couplings on the basis of nominal input torque ratings and commonly accepted rated engine governed speeds. Consult ZF for details concerning speed limits of standard offering torsional couplings, which can be less than the transmission limit. Special torsional couplings may be required for Survey Society Ice Classification requirements.