



## ZF 9050 NR2B

Vertical offset, remote mount marine transmission.

### Description

- 2 shaft non reverse reduction transmission for waterjet applications and ccp's.
- Input shaft vertical below output shaft.
- Hydraulic clutch mounted on the input shaft.
- Fully works tested, reliable and simple to install .
- Suitable for heavy duty fast ferry applications. Also suitable for other weight sensitive craft, e.g. high speed motor yachts .
- Design, manufacture and quality control standards comply with ISO 9001 and AQAP .
- Compatible with all types of engines.
- Compact, space-saving design, complete with oil cooler, pump and full flow filter.

### Features

- Lightweight and robust aluminum alloy casing (sea water resistant) .
- Case hardened and precisely ground gear teeth for long life and smooth running .
- Smooth and reliable hydraulic shifting with electric actuation .
- Suitable for multi engine installations.
- Airborn and structure born noise in accordance to ISO 8579 .

### Options

- Classification by all major Classification Societies on request .
- Engine-matched torsional coupling .
- Input flange .
- Monitoring kit .
- Mounting brackets .
- Trailing pump .
- One power take off (PTO) drive with SAE connection, permanently connected and driven from the input shaft. .



# ZF 9050 NR2B

## Ratings

### Light Duty

RATIOS	MAX. TORQUE		POWER/RPM		INPUT POWER CAPACITY						MAX. RPM
	Nm	ftlb	kW	hp	1800 rpm		2000 rpm		2100 rpm		
					kW	hp	kW	hp	kW	hp	
<span style="color: red;">■</span> 1.515*, 1.742*, 2.036, 2.269*, 2.400*, 2.542, 2.739*, 2.957	15644	11538	1.6381	2.1967	2949	3954	3276	4393	3440	4613	2300
<span style="color: blue;">■</span> 3.250*	14735	10868	1.5429	2.0691	2777	3724	3086	4138	3240	4345	2300
<span style="color: green;">■</span> 3.448*	14075	10381	1.4738	1.9764	2653	3558	2948	3953	3095	4150	2300

\* Special Order Ratio.

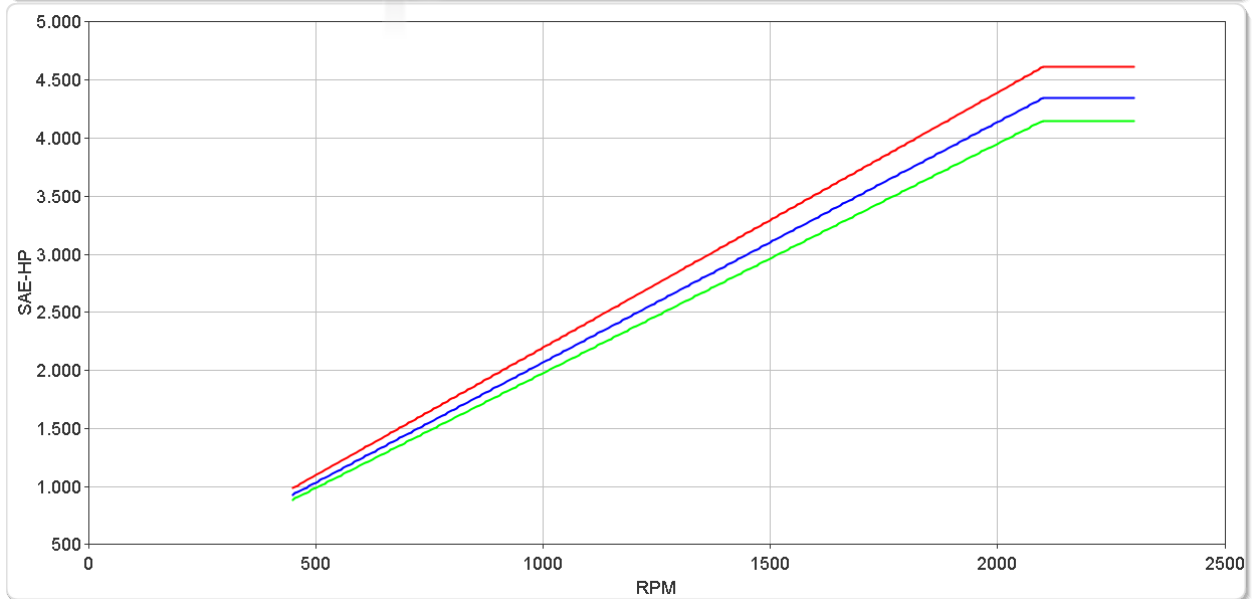
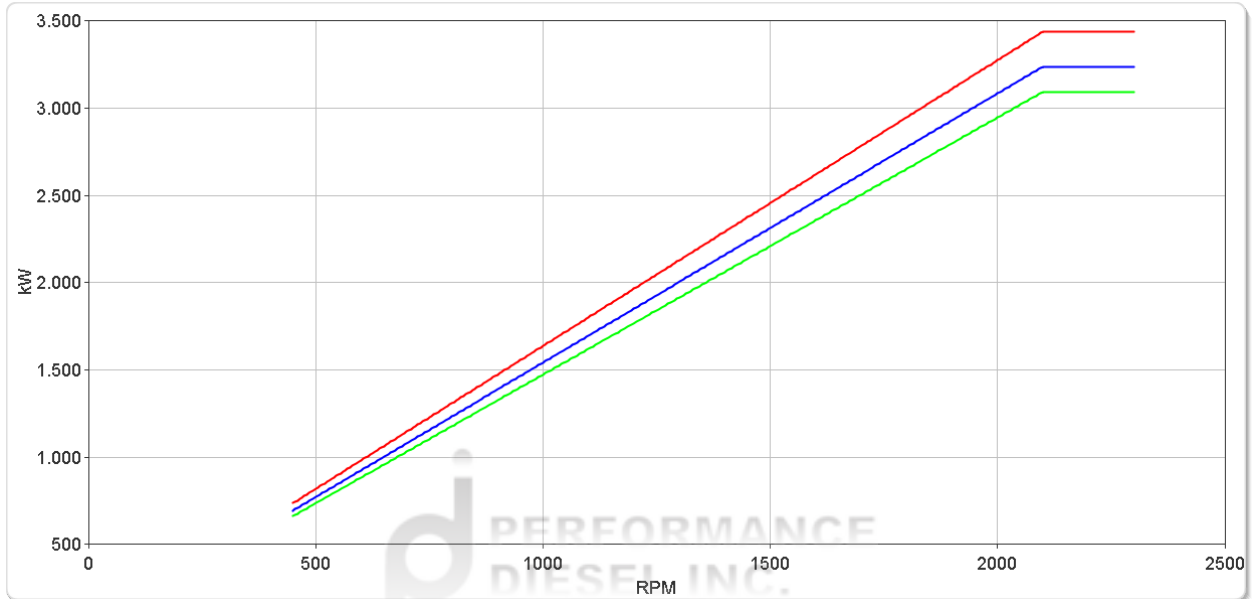

# ZF 9050 NR2B

## Ratings

### Medium Duty

RATIOS	MAX. TORQUE		POWER/RPM		INPUT POWER CAPACITY						MAX. RPM
	Nm	ftlb	kW	hp	1600 rpm		1800 rpm		2000 rpm		
					kW	hp	kW	hp	kW	hp	
1.515*, 1.742*, 2.036, 2.269*, 2.400*, 2.542, 2.739*, 2.957	14000	10326	1.4660	1.9659	2346	3145	2639	3539	2932	3932	2300
3.250*	13203	9738	1.3825	1.8540	2212	2966	2489	3337	2765	3708	2300
3.448*	12606	9298	1.3200	1.7701	2112	2832	2376	3186	2640	3540	2300

\* Special Order Ratio.

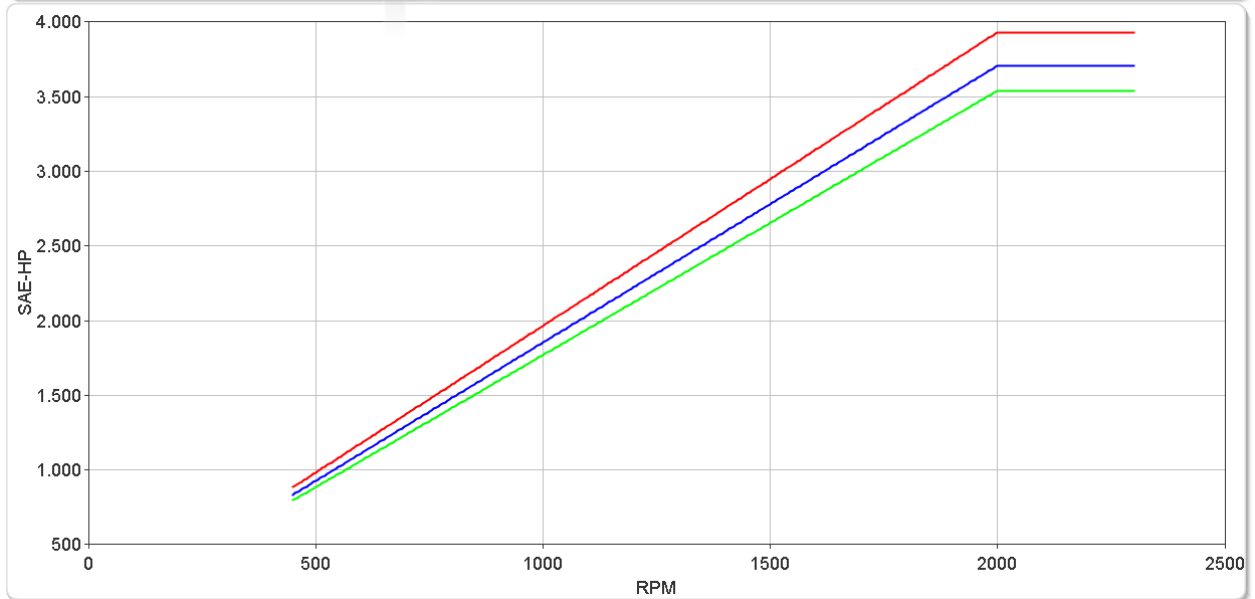
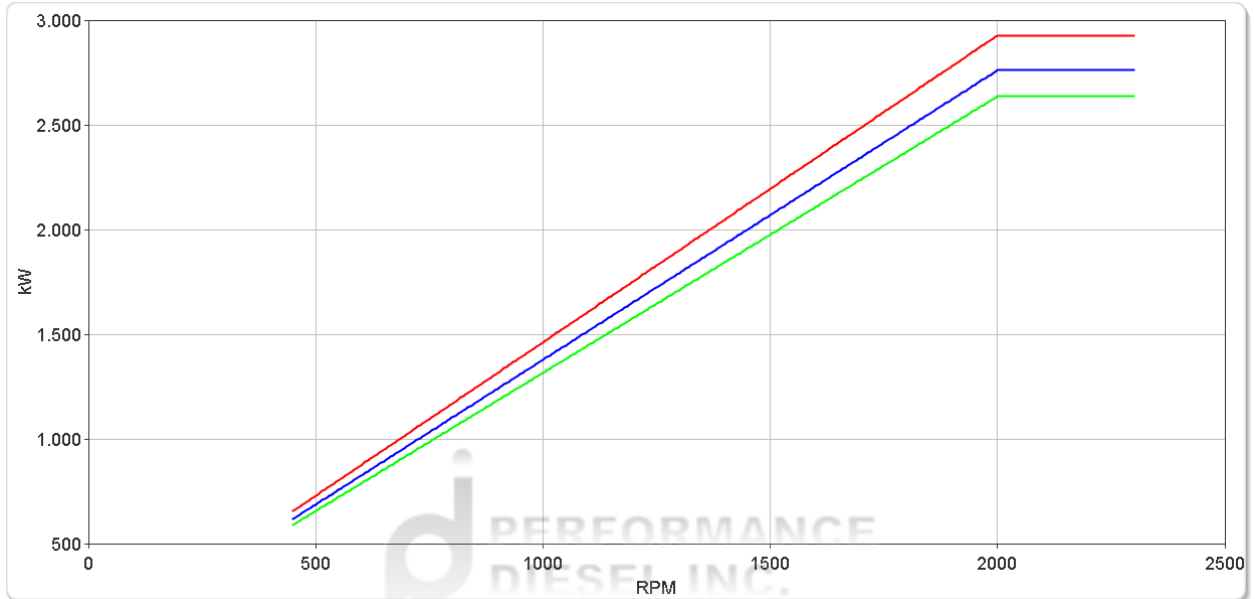

# ZF 9050 NR2B

## Ratings

### Continuous Duty

RATIOS	MAX. TORQUE		POWER/RPM		INPUT POWER CAPACITY						MAX. RPM
	Nm	ftlb	kW	hp	1200 rpm		1600 rpm		1800 rpm		
					kW	hp	kW	hp	kW	hp	
<span style="color: red;">■</span> 1.515*, 1.742*, 2.036, 2.269*, 2.400*, 2.542, 2.739*, 2.957	12709	9374	1.3308	1.7846	1597	2142	2129	2855	2395	3212	1800
<span style="color: blue;">■</span> 3.250*	11991	8844	1.2556	1.6838	1507	2021	2009	2694	2260	3031	1800
<span style="color: green;">■</span> 3.448*	11460	8452	1.2000	1.6092	1440	1931	1920	2575	2160	2897	1800

\* Special Order Ratio.

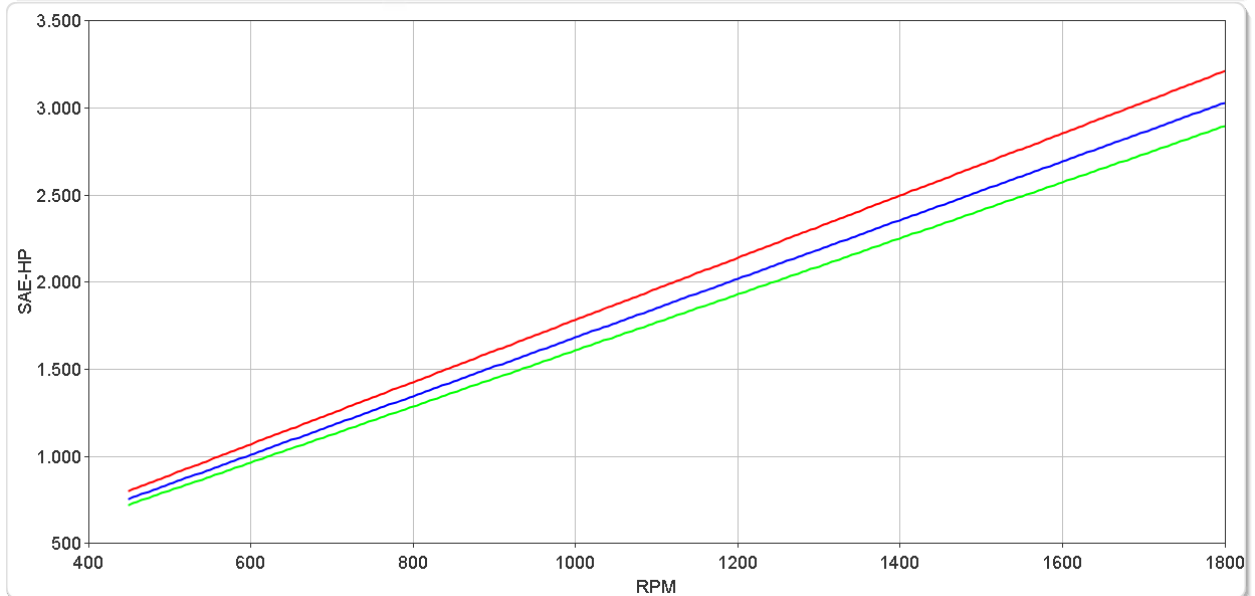
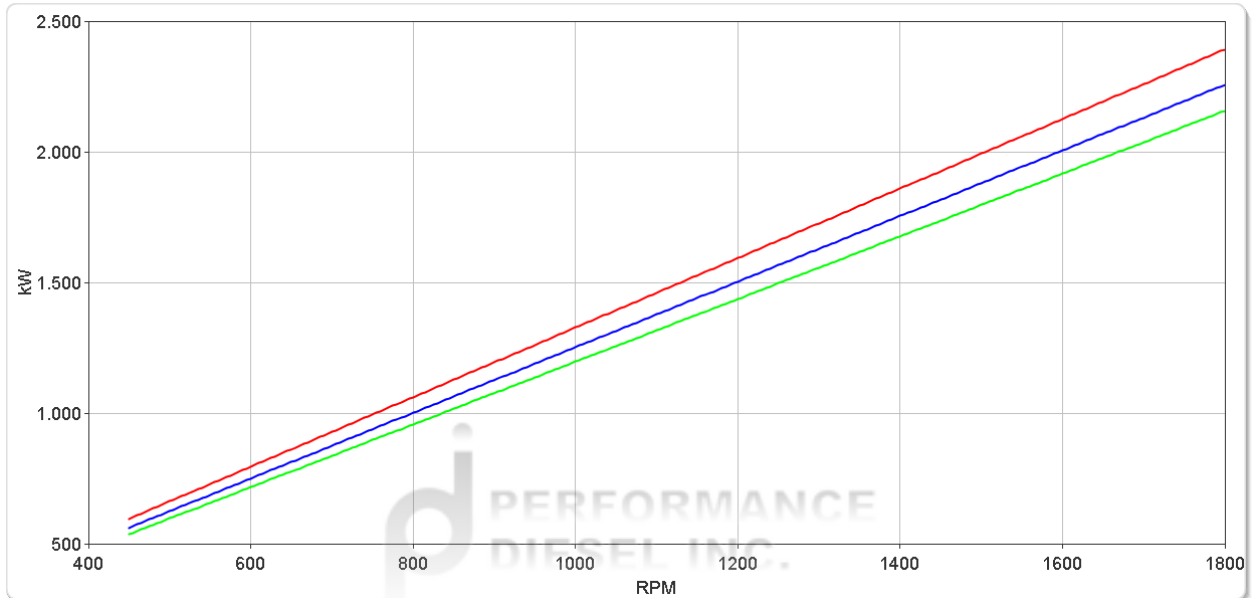

# ZF 9050 NR2B

## Dimensions

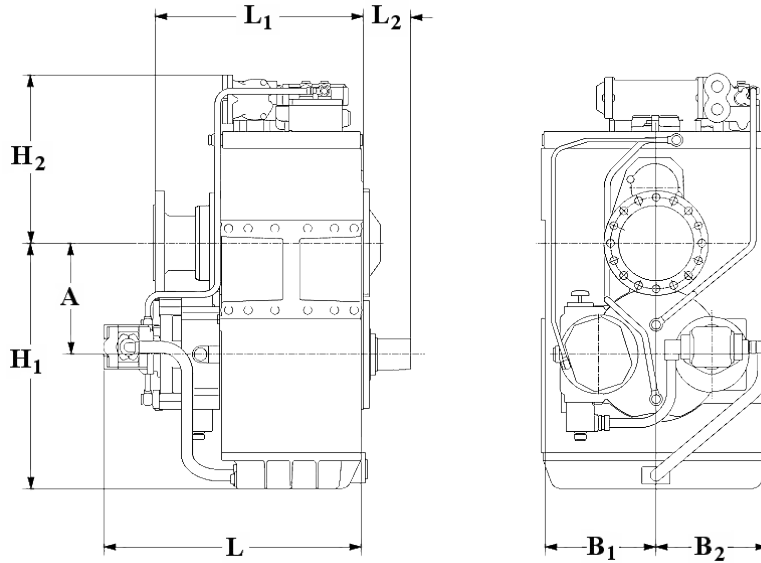

mm (inches)							
A	B <sub>1</sub>	B <sub>2</sub>	H <sub>1</sub>	H <sub>2</sub>	L	L <sub>1</sub>	L <sub>2</sub>
390 (15.4)	390 (15.4)	390 (15.4)	835 (32.9)	503 (19.8)	851 (33.5)	640 (25.2)	164 (6.46)
Weight kg (lb)				Oil Capacity Litre (US qt)			
1,020 ( 2,244)				55.0 (58.3)			

### Output Coupling Dimensions

A		B		C		D		Bolt Holes		
mm	in	mm	in	mm	in	mm	in	No.	Diameter (E)	
									mm	in
350	13.8	310	12.2	220	8.66	35.0	1.38	18	24.2	0.95

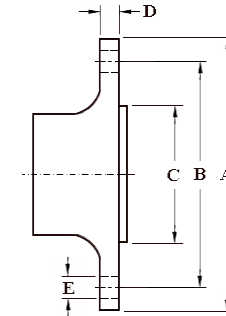

## Duty Definitions

<b>LIGHT DUTY DEFINITION</b>	Intermittent operation with large variations in engine speed and power
Average engine operating hours limit:	2500 hours/year (for hydraulic gearboxes smaller than the ZF 650 series, 2000 hours/year).
Typical hull forms:	Planing and semi-displacement.
Typical applications:	Private and charter, sport/leisure activities, naval and police activities.
<b>MEDIUM DUTY DEFINITION</b>	Intermittent operation with some variations in engine speed and power
Average engine operating hours limit:	4000 hours/year. 3500 hours/year for gearboxes smaller than ZF 2000 series and workboat ZF W2700 series.
Typical hull forms:	Semi-displacement and displacement
Typical applications:	Charter and commercial craft (example: crew boats and fast ferries), and naval and police activities.
<b>CONTINUOUS DUTY DEFINITION</b>	Continuous operation with little or no variations in engine speed and power
Average engine operating hours limit:	Unlimited
Typical hull forms:	Displacement.
Typical applications:	Heavy duty commercial vessels, tugs, fishing boats.

## Duty Ratings

Ratings apply to marine diesel engines at the indicated speeds. At other engine speeds, the respective power capacity (kW) of the transmission can be obtained by multiplying the Power/Speed ratio by the speed.

Approximate conversion factors:

1 kW = 1.36 metric hp

1 kW = 1.34 U.S. hp (SAE)

1 U.S. hp = 1.014 metric hp

1 Nm = 0.74 lb.ft.

Ratings apply to right hand turning engines, i.e. engines having counterclockwise rotating flywheels when viewing the flywheel end of the engine.

These ratings allow full power through forward and reverse gear trains, unless otherwise stated.

Contact your nearest ZF Sales and Service office for ratings applicable to gas turbines, gasoline (petrol) engines, as well as left hand turning engines, and marine transmissions for large horsepower capacity engines.

Ratings apply to marine transmissions currently in production or in development and are subject to change without prior notice.

**NOTE: THE MAXIMUM RATED INPUT POWER MUST NOT BE EXCEEDED (SEE RESPECTIVE RATINGS IN THE TECHNICAL DATA SHEETS)**

## Safe Operating Notice

The safe operation of ZF products depends upon adherence to technical data presented in our brochures. Safe operation also depends upon proper installation, operation and routine maintenance and inspection under prevailing conditions and recommendations set forth by ZF. Damage to transmission caused by repeated or continuous emergency manoeuvres or abnormal operation is not covered under warranty. It is the responsibility of users and not ZF to provide and install guards and safety devices, which may be required by recognized safety standards of the respective country (e.g. for U.S.A. the Occupational Safety Act of 1970 and its subsequent provisions).

## Monitoring Notice

The safe operation of ZF products depends upon adherence to ZF monitoring recommendations presented in our operating manuals, etc. It is the responsibility of users and not ZF to provide and install monitoring devices and safety interlock systems as may be deemed prudent by ZF. Consult ZF for details and recommendations.

## Torsional Responsibility and Torsional Couplings

The responsibility for ensuring torsional compatibility rests with the assembler of the drive and driven equipment. ZF can accept no liability for gearbox noise caused by vibrations or for damage to the gearbox, the flexible coupling or to other parts of the drive unit caused by this kind of vibration. Contact ZF for further information and assistance. ZF recommends the use of a torsional limit stop for single engine powered boats, wherein loss of propulsion power can result in loss of control. It is the buyer's responsibility to specify this option, which can result in additional cost and a possible increase in installation length.

ZF can accept no liability for personal injury, loss of life, or damage or loss of property due to the failure of the buyer to specify a torsional limit stop. ZF selects torsional couplings on the basis of nominal input torque ratings and commonly accepted rated engine governed speeds. Consult ZF for details concerning speed limits of standard offering torsional couplings, which can be less than the transmission limit. Special torsional couplings may be required for Survey Society Ice Classification requirements.

