

## ZF W17200 NR

Vertical offset, remote mount marine transmission.

### Description

- Non-reversing reduction marine transmission with hydraulically actuated multi-disc clutches .
- Non-Clutchable NC version also available .
- Robust design also withstands continuous duty in workboat applications .
- Fully works tested, reliable and simple to install .
- Compatible with all types of engines and propulsion systems .
- Design, manufacture and quality control standards comply with ISO 9001 and APQP .
- Easy onboard maintenance .

### Features

- Robust, torsion - resistant housing (cast iron) .
- Case hardened and precisely ground gear teeth for long life and smooth running .
- Output shaft thrust bearing designed to take maximum propeller thrust astern and ahead .
- Free standing .
- Compact, space-saving design, complete with oil cooler, pump and full flow filter .
- Smooth and reliable hydraulic shifting (electrically activated with mechanical override) with pressure modulation for controlled engagement .
- Suitable for twin engine installations .
- Emergency "get home" capability .
- Oil cooler complete with fittings .
- Cast-on brackets .
- In most cases standard ratings are accepted by major classification bureau. Ratings are valid for applications without ice notation. .

### Options

- Engine-matched torsional coupling .
- Pneumatic clutch actuation .
- Standard monitoring system .
- Classification certification from all major Classification Societies available on request .
- Special monitoring (acc. Classification Society requirements) .
- PTO (live or clutchable) .
- PTI (second input device) .
- PTH (home device) .
- Standby oil pump .
- Trailing pump .
- Interface for CPP or Steering Pump .
- Higher engine speeds can be evaluated on request.
- External and internal brake .
- Engine Wise version is also available .

# ZF W17200 NR

## Ratings

### Continuous Duty

RATIOS	MAX. TORQUE		POWER/RPM		INPUT POWER CAPACITY						MAX. RPM
	Nm	ftlb	kW	hp	720 rpm		1000 rpm		1200 rpm		
6.000, 6.522, 6.909*	20342	15003	2.1301	2.8564	1534	2057	2130	2856	2556	3428	1600
7.238	18336	13524	1.9200	2.5748	1382	1854	1920	2575	2304	3090	1600

\* Special Order Ratio.

Higher engine speeds can be evaluated on request.

Ratings shown for the ZF W17000, and larger gearboxes, are valid for applications without ice classification and comply with BV (Bureau Veritas) rules.

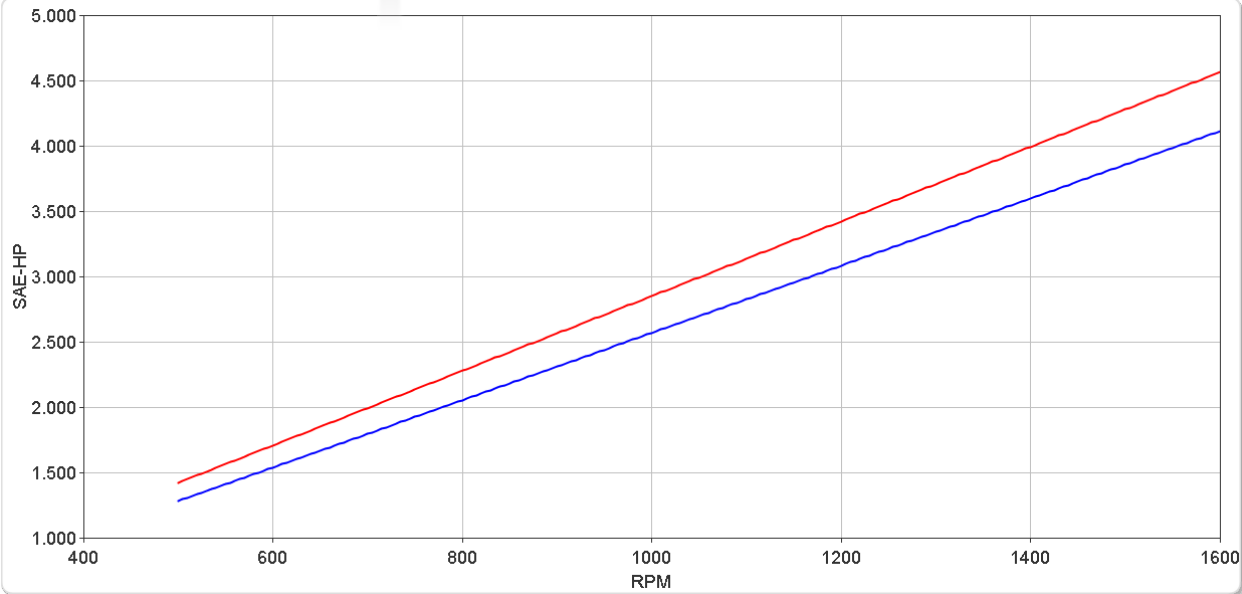
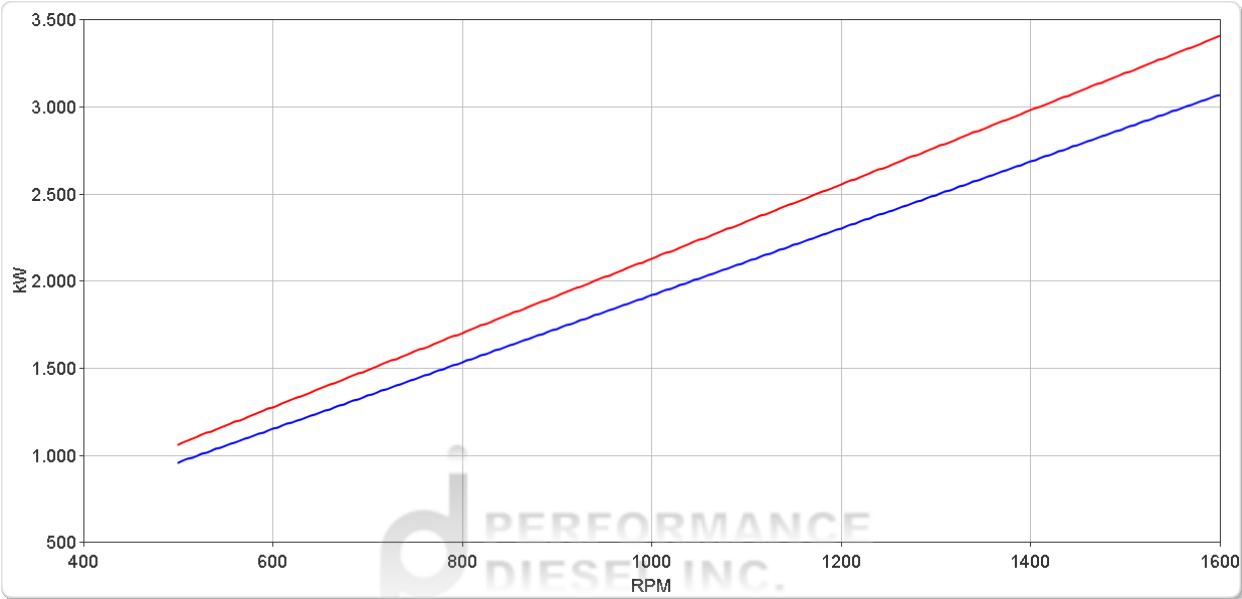

# ZF W17200 NR

## Dimensions

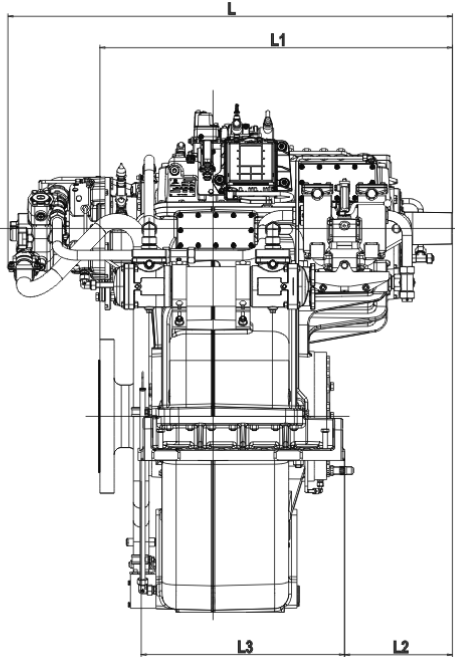
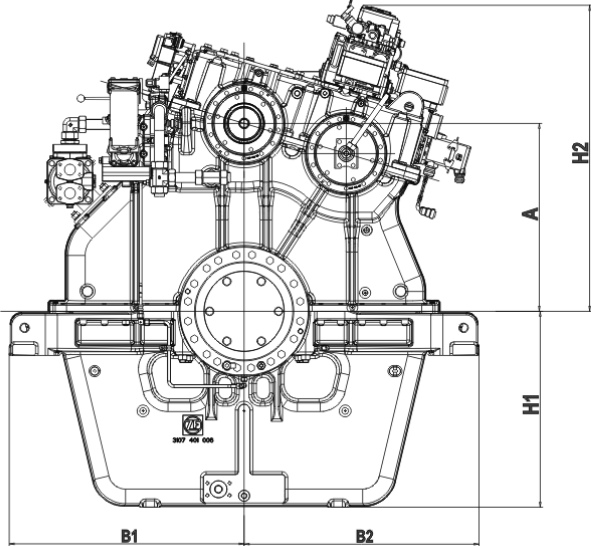

mm (inches)									
A	B <sub>1</sub>	B <sub>2</sub>	H <sub>1</sub>	H <sub>2</sub>	L	L <sub>1</sub>	L <sub>2</sub>	L <sub>3</sub>	
700 (27.6)	925 (36.4)	925 (36.4)	825 (32.5)	1,180 (46.5)	1,866 (73.5)	1,504 (59.2)	488 (19.2)	925 (36.4)	
Weight kg (lb)					Oil Capacity Litre (US qt)				
5,250 ( 11,550)					187 ( 198)				

### Output Coupling Dimensions

A		B		C		D		No.	Bolt Holes Diameter (E)	
mm	in	mm	in	mm	in	mm	in		mm	in
600	23.6	530	20.9	340	13.4	60.0	2.36	15	29.0	1.14

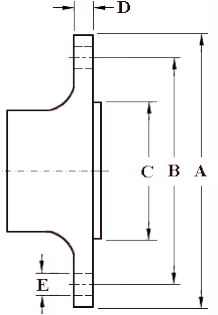

### PTO Configurations

Front PTO23 (NR\* Version)

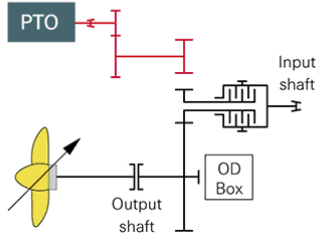

Front PTO81 (NR\* Version)

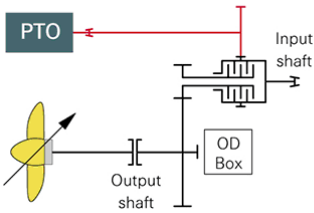

Front PTO83 (NR\* Version)

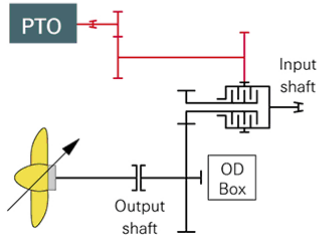

Front PTI24 (NR\* Version)

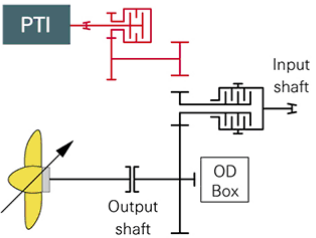

Top PTO71 (R\*+NR\* Version)

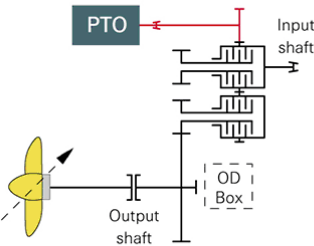

Top PTO72 (R\*+NR\* Version)

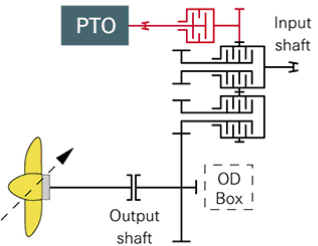

Top PTO73 (R\*+NR\* Version)

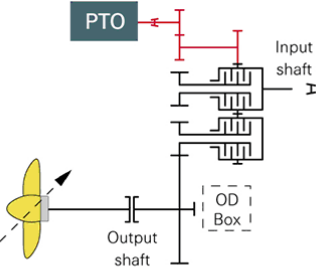

Top PTO74 (R\*+NR\* Version)

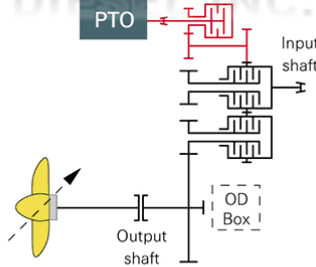

Front PTO73 (aux. pump)  
with SAE A to CC (NR\* Version)

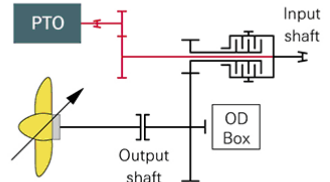

Brake (NR\* Version)

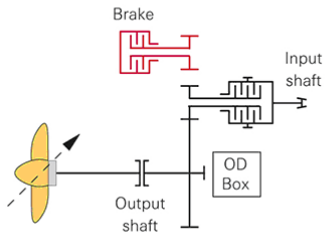

\*R= Reversing \*NR= Non-Reversing

## Duty Definitions

**CONTINUOUS DUTY DEFINITION** Continuous operation with little or no variations in engine speed and power

Average engine operating hours limit: **Unlimited**

Typical hull forms: **Displacement.**

Typical applications: **Heavy duty commercial vessels, tugs, fishing boats.**

## Duty Ratings

Ratings apply to marine diesel engines at the indicated speeds. At other engine speeds, the respective power capacity (kW) of the transmission can be obtained by multiplying the Power/Speed ratio by the speed.

Approximate conversion factors:

1 kW = 1.36 metric hp

1 kW = 1.34 U.S. hp (SAE)

1 U.S. hp = 1.014 metric hp

1 Nm = 0.74 lb.ft.

Ratings apply to right hand turning engines, i.e. engines having counterclockwise rotating flywheels when viewing the flywheel end of the engine. These ratings allow full power through forward and reverse gear trains, unless otherwise stated.

Contact your nearest ZF Sales and Service office for ratings applicable to gas turbines, gasoline (petrol) engines, as well as left hand turning engines, and marine transmissions for large horsepower capacity engines.

Ratings apply to marine transmissions currently in production or in development and are subject to change without prior notice.

**NOTE: THE MAXIMUM RATED INPUT POWER MUST NOT BE EXCEEDED (SEE RESPECTIVE RATINGS IN THE TECHNICAL DATA SHEETS)**

## Safe Operating Notice

The safe operation of ZF products depends upon adherence to technical data presented in our brochures. Safe operation also depends upon proper installation, operation and routine maintenance and inspection under prevailing conditions and recommendations set forth by ZF. Damage to transmission caused by repeated or continuous emergency manoeuvres or abnormal operation is not covered under warranty. It is the responsibility of users and not ZF to provide and install guards and safety devices, which may be required by recognized safety standards of the respective country (e.g. for U.S.A. the Occupational Safety Act of 1970 and its subsequent provisions).

## Monitoring Notice

The safe operation of ZF products depends upon adherence to ZF monitoring recommendations presented in our operating manuals, etc. It is the responsibility of users and not ZF to provide and install monitoring devices and safety interlock systems as may be deemed prudent by ZF. Consult ZF for details and recommendations.

## Torsional Responsibility and Torsional Couplings

The responsibility for ensuring torsional compatibility rests with the assembler of the drive and driven equipment. ZF can accept no liability for gearbox noise caused by vibrations or for damage to the gearbox, the flexible coupling or to other parts of the drive unit caused by this kind of vibration.

Contact ZF for further information and assistance. ZF recommends the use of a torsional limit stop for single engine powered boats, wherein loss of propulsion power can result in loss of control. It is the buyer's responsibility to specify this option, which can result in additional cost and a possible increase in installation length.

ZF can accept no liability for personal injury, loss of life, or damage or loss of property due to the failure of the buyer to specify a torsional limit stop. ZF selects torsional couplings on the basis of nominal input torque ratings and commonly accepted rated engine governed speeds. Consult ZF for details concerning speed limits of standard offering torsional couplings, which can be less than the transmission limit. Special torsional couplings may be required for Survey Society Ice Classification requirements.