

ZF 15 M

TECHNICAL DATA SHEET

ZF 15 M SERIES PRODUCT DETAILS

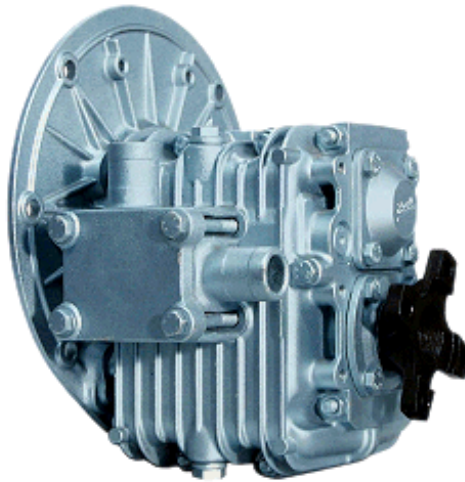

Description

- Reverse reduction marine transmission with mechanically actuated multi-disc clutches
- Suitable for high performance applications in luxury sailboats, motoryachts, fishing boats, etc.
- Robust design also withstands continuous duty in workboat applications
- Fully works tested, reliable and simple to install
- Design, manufacture and quality control standards comply with ISO 9001

Features

- Lightweight and robust aluminum alloy casing (sea water resistant)
- Case hardened and precisely ground gear teeth for long life and smooth running
- Output shaft thrust bearing designed to take maximum propeller thrust
- Compact, space saving design



ZF 15 M

RATINGS

Ratios		Power Factor		Input Power Capacity							
'A' Pos	'B' Pos	kW/RPM	hp/RPM	kW	hp	kW	hp	kW	hp	kW	hp
Pleasure Duty - Diesel ¹²				3000 RPM		3600 RPM		3800 RPM		5000 RPM (max)	
1.556	1.955	0.0152	0.0204	46	61	55	73	55	73	55	73
1.875	1.955	0.0152	0.0204	46	61	55	73	55	73	55	73
Light Duty - Diesel ¹²				2800 RPM		3000 RPM		3600 RPM		5000 RPM (max)	
1.556	1.955	0.0137	0.0184	38	52	41	55	49	66	50	67
1.875	1.955	0.0137	0.0184	38	52	41	55	49	66	50	67
Medium Duty - Diesel ¹²				2100 RPM		2500 RPM		2800 RPM		5000 RPM (max)	
1.556	1.955	0.0131	0.0176	28	37	33	44	37	49	46	61
1.875	1.955	0.0121	0.0162	25	34	30	41	34	45	46	61
Continuous Duty - Diesel ¹²				1800 RPM		2300 RPM		2600 RPM		5000 RPM (max)	
1.556	1.955	0.0126	0.0169	23	30	29	39	33	44	40	53
1.875	1.955	0.0115	0.0154	21	28	26	35	30	40	40	53

* Special Order Ratio

'A' Pos: Continuous running position

'B' Pos: Reverse position

Footnotes:

¹² Reduced power capacity by the following shock factors: 1 cylinder engine ÷ 1.25, 2 cylinder engine ÷ 1.20, 3 cylinder engine ÷ 1.15

ZF 15 M

DIMENSIONS

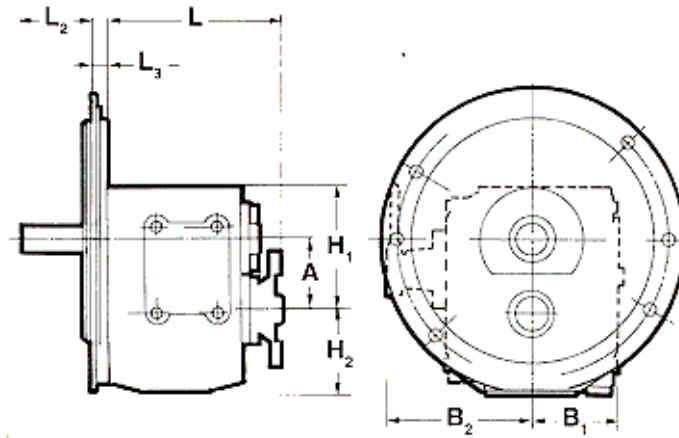

A	B1	B2	H1	H2	L0	L2
Millimeter (mm)						
72.0	80.0	134.0	122.0	89.0	193.0	60.0
Inch (in)						
2.83	3.15	5.28	4.8	3.5	7.6	2.36
Weight (kg)		Weight (lb)		Amount of Oil (l)		Amount of Oil (qt)
13		29		0.6		0.6

BELL HOUSING DIMENSIONS

Name	A		B		C		L3		Bolt Holes		
	mm	in	mm	in	mm	in	mm	in	No.	Diameter	
										mm	in
SAE 4	361.95	14.25	381.0	15.0	403.23	15.88	33.0	1.3	12	10.32	0.41
SAE 5	314.33	12.38	333.38	13.13	355.6	14.0			8	10.32	0.41
SAE 6	266.7	10.5	285.75	11.25	307.98	12.13			8	10.32	0.41
B/W							15.0	0.59			
Yanmar JH											

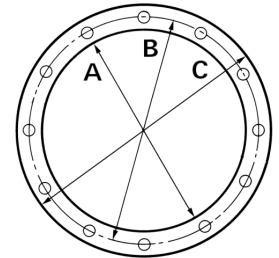

OUTPUT FLANGE DIMENSIONS

A		B		C		D		Bolt Holes		
mm	in	mm	in	mm	in	mm	in	No.	Diameter (E)	
									mm	in
102.0	4.02	82.5	3.25	63.5	2.5	10.0	0.39	4	10.5	0.41

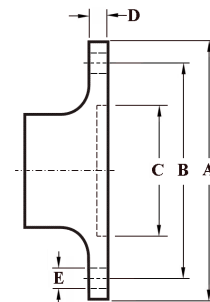

GENERAL INFORMATION

Duty Definitions

Pleasure Duty

Highly intermittent operation with very large variations in engine speed and power.

Average engine operating hours limit:	500 hours/year 300 hours/year for mechanical gearboxes
Typical hull forms:	Planing
Applications:	Private, non-commercial, non-charter leisure activities, no racing

Light Duty

Intermittent operation with large variations in engine speed and power.

Average engine operating hours limit:	2500 hours/year (for hydraulic transmissions smaller than ZF 2000 series, 2000 hours/year)
Typical hull forms:	Planing and semi-displacement
Typical applications:	Private and charter, sport/leisure activities, naval and police activities

Medium Duty

Intermittent operation with some variations in engine speed and power.

Average engine operating hours limit:	4000 hours/year (for hydraulic transmissions smaller than ZF 2000 series and workboat ZF W2700 series, 3500 hours/year)
Typical hull forms:	Semi-displacement and displacement
Typical applications:	Charter and commercial craft (example: crew boats), and naval and police activities

Continuous Duty

Continuous operation with little or no variations in engine speed and power.

Average engine operating hours limit:	Unlimited
Typical hull forms:	Displacement
Typical applications:	Heavy duty commercial vessels

Technical Notes

Duty Ratings

Ratings apply to marine diesel engines at the indicated speeds. At other engine speeds, the respective power capacity (kW) of the transmission can be obtained by multiplying the Power/Speed ratio by the speed. Approximate conversion factors:

- 1 kW = 1.36 metric hp
- 1 kW = 1.34 U.S. hp (SAE)
- 1 U.S. hp = 1.014 metric hp
- 1 Nm = 0.74 lb.ft.
- 1 Kg = 0.454 lb

Ratings apply to right hand turning engines, i.e. engines having counterclockwise rotating flywheels when viewing the flywheel end of the engine. These ratings allow full power through forward and reverse gear trains, unless otherwise stated. Contact your nearest ZF Sales and Service office for ratings applicable to gas turbines, as well as left hand turning engines, and marine transmissions for large horsepower capacity engines. Ratings apply to marine transmissions currently in production or in development and are subject to change without prior notice.

NOTE: The maximum rated input power must not be exceeded (see respective ratings in the technical data sheets).

Safe Operating Notice

The safe operation of ZF products depends upon adherence to technical data presented in our brochures. Safe operation also depends upon proper installation, operation and routine maintenance and inspection under prevailing conditions and recommendations set forth by ZF. Damage to transmission caused by repeated or continuous emergency manoeuvres or abnormal operation is not covered under warranty. It is the responsibility of users and not ZF to provide and install guards and safety devices, which may be required by recognized safety standards of the respective country (e.g. for U.S.A. - the Occupational Safety Act of 1970 and its subsequent provisions).

Monitoring Notice

The safe operation of ZF products depends upon adherence to ZF monitoring recommendations presented in our operating manuals, etc. It is the responsibility of users and not ZF to provide and install monitoring devices and safety interlock systems as may be deemed prudent by ZF. Consult ZF for details and recommendations.

Survey Society Classification

In most cases, the maximum medium and continuous duty ratings permitted by ZF are accepted in full by major classification societies. If classification is required, contact ZF regarding proper procedures (also for yacht service and ice classifications service).

Dimensions and Weights

Dimensions and weights refer to transmissions with bell housing (where appropriate) but excluding options such as: trolling valves, power take-offs, propeller shaft companion flanges, torsional couplings etc.

Torsional Vibration and Torsional Couplings

The responsibility for ensuring torsional vibration compatibility rests with the overall propulsion system integration responsible party. Compatibility check of torsional vibration must include excitations induced by engine governor. ZF cannot accept any liability for gearbox noise or for damage to the gearbox, the flexible coupling or to other parts of the drive unit caused by torsional vibrations. Contact ZF for further information and assistance.

For single engine powered boats, where loss of propulsion can result in loss of control, ZF recommends the use of a torsional limit stop. It is the buyer's responsibility to specify this option. ZF cannot accept any liability for personal injury, loss of life or damage or loss of property due to the failure of the buyer to specify a torsional limit stop.

ZF selects torsional couplings on the basis of nominal input torque at commonly rated engine speeds. Consult ZF for details concerning speed limits of standard offered torsional couplings, which can be below transmission limits. Special torsional couplings may be required for Survey Society requirements.